

41737X

THE

LADIES' TAILOR

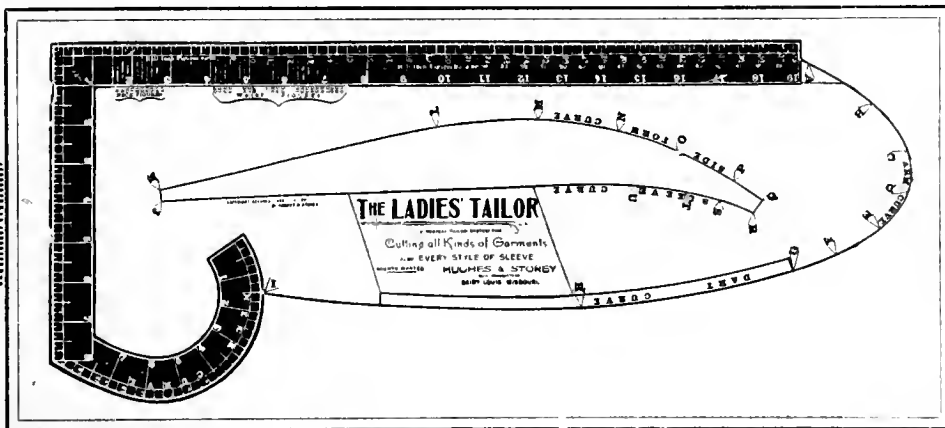

15
9416

COMPLETE INSTRUCTOR

..... BY

HUGHES & STOREY,

ST. LOUIS, MO.

COPYRIGHT SECURED OCTOBER, 1892, BY HUGHES & STOREY.

MEASURES.



To supply the demand of tailor-cut patterns, we have had instruction sheets printed which illustrates and shows precisely how to take accurate measures, and gives blank spaces for writing the same. Before ordering a pattern, our patrons (if not already in possession of the Ladies' Tailor instruction book) must send us 10 cents in postage for one of these instruction sheets, then have her measure taken and return with her order for the pattern wanted. We do not cut patterns from measures taken according to the directions given by charts or other methods, because as a rule they are unreliable. Dressmakers who desire to make up dresses for their customers at a distance, or wish to increase their business by filling orders by mail, will find these instruction sheets the very thing needed to assist them in this part of their business. They can be sent to their patrons and measures obtained that will afford both them and their customer a basis for confidence that beautifully fitting garments will be secured. These instruction sheets are furnished to dressmakers at the rate of 25 cents per dozen.

PRICE OF TAILOR-CUT PATTERNS.

When we take your measure, or when it is taken according to our instructions, we guarantee the pattern to fit.

Basque, Coat, Seamless Waist, Cape, Riding Habit, (Jacket or Habit proper), Riding Skirt, or Trousers.....	\$1 50 each
Riding Habit, full suit, including Habit Skirt and Trousers.....	4 00
Princess, Wrapper, Ulster, Newmarket, Dolman, or Circular.....	2 50 each
Skirt, Boys' Coat, Boys' Knee Pants, Gents' Shirts, or Children's Suits.....	1 00 each
Sleeves, Girdles, etc.....	50 each
Collars.....	25 each

GRADED PATTERNS.

When you order a pattern without taking a complete measure you should send us the bust measure and we will send you a regular graded pattern, which will give a handsome outline and symmetrical shapes, but not guaranteed to fit, for the following prices:

Coat, Cape, Riding Habit, Riding Skirt, or Trousers.....	\$ 75 each
Princess, Wrappers, Ulsters, Dolman, Cloaks, Circulars, etc.....	1 50 each
Basque, Skirt, Boys' Coat, Knee Pants, Gents' Shirts, Child's Suit.....	50 each
Sleeves.....	25 each

DRAFTINGS AND PATTERNS.

It is our desire to assist our agents and patrons who have purchased our System by correspondence in overcoming any difficulties they may have in learning to make any draftings given in our instruction books. The best way to meet difficulties of this kind in making any draftings is to make a drafting as nearly correct as possible and send it to us by mail, and we will make a drafting, numbering and lettering every line and dot the same as given on diagrams in our instruction books, and trace out a pattern and return both drafting and pattern. From this drafting and traced pattern, with the aid of our printed instructions, anyone can easily learn to make perfect draftings to any measure. These draftings and patterns will be made to any measure desired, and when measures are not mentioned will be made to those given in our instruction book. These draftings and patterns will be furnished to our agents and those who are learning our System at a discount of 50 per cent. on the prices given above for tailor-cut patterns.

●●●●● PREFACE. ●●●●●

THE theory adopted in the invention of The Ladies' Tailor System of dress and cloak cutting, and the development of its printed instructions is, that the cutting of ladies' garments is mechanical work, and should be controlled only by the same scientific principles so successfully used by all the expert mechanics of the world. It is universally admitted that the square and compass form the very foundation of all mechanics, therefore, we have united in this System all the curves of the compass used in cutting clothing with the mechanic's square, and the lessons contained in this instruction book teach how to apply these principles to cutting all styles of ladies' and children's garments. Another fundamental feature of this System, and which distinguishes it as being absolutely new and gives its superiority over all others heretofore published, is that what is called the law of proportion is discarded altogether, so far as obtaining the correct size of any portion of the draft is concerned, and strictly square measurement alone is confidently relied upon to obtain the true size of a perfect fitting garment. Proportion, however, is fully recognized when it comes to the shaping of the various pieces so as to obtain a handsome outline and symmetrical shapes, and to make each piece of the garment in perfect harmony. In other words, in all draftings made by The Ladies' Tailor System, actual measurement and harmonious proportions go hand in hand. The cutter is taught to rely exclusively on the measures to secure a draft that will define the actual size, and at the same time to combine harmonious shapes and proportions for each separate figure. This principle is not yet appreciated by many cutters. There are thousands who still ignore the relation of the measures with proportion, and rely exclusively on patterns, charts, models, machines, etc., which only give graduated patterns, and then hope to make up for the deficiencies in their drafts by their skill in refitting. Others go one step further, and take what they consider a well proportioned draft and endeavor to correct its deficiencies by the application of some of the more important measures, and the remainder by refitting. It is self-evident, that those who use a perfect tailor System do their work systematically and aim to do their cutting exactly right, can be reasonably sure of excelling all who do not even try to do so, but who intend after they have cut a misfitting garment to make up for the work they have done wrong by altering and changing. It is our desire to give dress-makers, and all ladies who appreciate improvements in this direction, a change in this old-fashioned and slovenly manner of work, and place before them a System that employs only the principles that all expert mechanics must say are correct, because they are identical with those used by themselves. The following objections to so thorough a System are sometimes raised which are worthy of notice :

1st. "A scientific System is too complicated and difficult for young students." Nothing could be further from the truth than this idea. If learned on proper principles garment-cutting, instead of being difficult, soon becomes an attractive study, and to become a proficient and expert cutter is much easier than is usually supposed.

2nd. "It takes too much time to take measures and make draftings accurately." The truth is, that the very best way to save time in dressmaking is to be accurate and careful in taking measures and in making draftings, because, when this preliminary part of the work is done correctly it will as a rule save all the time that is lost, both for the dress-maker and her customer in refitting, and will always do so if the garment is properly basted and made up ; not only so, but it saves all the worry, trouble and dissatisfaction that frequently results from fitting a garment several times.

3rd. "There are so many methods of cutting, each claiming superiority, that I think one is as good as another." Where there is so much room for improvement, as there is in dressmaking, it seems plain that a System that substitutes actual measurement for what has heretofore been only proportion or guess work, possesses advantages, and that some of the methods in use must be better than others, and that one can be selected which is truly the best. The Ladies' Tailor is presented by the authors with the conviction, that when it is critically examined and compared with others, that it will be so denominated. We presume, however, that those who prefer to do their work by chance and believe one way is as good as another, that a set of graduated patterns is quite in harmony with their capacity. It is confidently believed that the instructions contained in this book, when thoroughly mastered, will give the cutter such a comprehensive knowledge of cutting ladies' garments, that they will be able to reproduce any new pattern or drafting that may come out in the future, and will be well qualified to fill the most responsible positions as cutters in the best establishments in this country.

TREATISE ON DRESS CUTTING.

The public can reasonably expect, in this age of improvement, that those who profess to be practical dress-makers should not only be able to do good sewing, finishing, draping and designing, but that they should be masters of a System of Dress Cutting, the accuracy of which is sufficient to give the same assurance when they leave an order for a dress that a good fit will be secured that a gentleman has when he leaves his order for a suit with a first class tailor. This expectation is sure to meet with disappointment so long as there are so many thousands of dressmakers who really possess nothing better than charts by which all their garments are cut (the term charts includes all methods of cutting which cut by proportion, whether it is a pasteboard chart with holes arranged by guess or a machine chart with movable slides or methods that use a square for part of its work only and scales or proportionate figures for the remainder.) The worthlessness of charts is self-evident when we consider the fact that there are no two forms alike any more than there are two faces, and that all charts give the same proportion and the same shapes for all kinds of forms. This is a matter of serious importance to all, especially to the ambitious dressmaker, because it forms the very foundation of success in her business.

All expert cutters know that a badly cut garment can never be made to fit properly, as the changing of seams here and there throws the entire waist out of balance, spoils the shape and symmetry of the different pieces, and completely ruins the grace and beauty of the garment. No amount of good sewing, fine finishing, elaborate trimming or stylish draping can possibly remedy it. A first-class System, based on unflinching geometrical principles which will uniformly insure success and give the enterprising modiste thorough control of this part of her profession, becomes a prime factor.

THE LADIES' TAILOR SYSTEM

Combines all the qualities that meet this necessity. Those who use such inferior methods must always remain inferior dressmakers, because their methods alone are sufficient to prevent them from excelling in their profession, regardless of any amount of natural ability, taste or experience they may have. It does not follow, however, that all who possess this System will be equally good cutters. Two cutters may be employed in the same establishment, using the same System, and obtain very different results. One takes loose, easy measures, the other takes them more closely. One may carelessly take incorrect measures, while the other displays the greatest care in taking accurate measures. One is superficial and careless, paying little or no attention to details, the other is accurate and thorough, and observes closely every peculiarity in different figures, the hardness or softness of the tissues, the quality of the material to be used, etc., etc., and displays good taste and skill, not only in obtaining the correct size in every part of his draftings, but in shaping the various pieces so as to be the most becoming and give the most artistic effect to each different form.

In no branch of dressmaking does the use of good judgment yield such fruitful results. A well cut dress, with each of the pieces the proper size and shape, not only means a good fit, but gives grace and beauty of outline, ease and comfort to the one who wears it, is much more easily made, wears longer, looks better, gives greater satisfaction, and last but not least, is always the best possible advertisement for the dressmaker wherever it moves. For anyone who uses **THE LADIES' TAILOR** to become an expert cutter in a very short time, is a very easy thing.

One word alone expresses the quality necessary to win this accomplishment. That word is **ACCURACY**. **ACCURACY** in taking measures, **ACCURACY** in making draftings, **ACCURACY** in tracing the lining, **ACCURACY** in basting. These four things are absolutely necessary for success. With these, perfect fitting dresses without the alteration of one stitch are certain. Without them, or any one of them, some change will have to be made.

All intelligent cutters know that Dress Cutting is mechanical work, and that the square and compass are the basis of all mechanics. **THE LADIES' TAILOR** is the square of inches combined with all the curves of the compass which are used in cutting clothing. It can therefore never be wrong. One great advantage to the modiste who uses it is that she always knows that if the slightest alteration in any garment is necessary, it is due to no fault in her system of work, but to errors either in taking measures, making the drafting or putting together. She is thus enabled in a moment to correct the mistakes, and by avoiding them in the future, soon become a very skillful and expert cutter.

SUGGESTIONS TO DRESSMAKERS.

“There is room at the top,” is an expression that conveys an idea that is applicable not only to professions but is pre-eminently true in dressmaking. The salaries of expert cutters, foreladies and stylish dressmakers vary all the way from \$12.00 to \$75.00 per week according to ability. It is therefore self-evident that all ladies' tailors, modistes, and especially young dressmakers should desire to excel in their business and the following suggestions are given for the purpose of aiding them to do so.

1st. **COMMENCE WITH A FIXED DETERMINATION TO BE SUCCESSFUL.** Remember that there is no excellence without great labor, that to win the highest honors and greatest reward demands faithful, pains-taking, care, close application to your business and perseverance. Any person of ordinary intelligence can reasonably expect success, if these principles are continually followed.

2nd. **FOSTER AND CULTIVATE A SPIRIT OF CONFIDENCE IN YOURSELF AND IN YOUR OWN ABILITY.** Many young dressmakers suffer disaster and defeat in the battle of life so far as their business is concerned simply and only because they are forever mistrusting themselves and fearful that they cannot accomplish the work that thousands of others do. You should, however, see to it that this self confidence is not merely self conceit, but that you actually possess knowledge and ability. Set your heart on becoming an artist in your business, worthy of the confidence of the public, and you will soon have a good share of the public's patronage. Self conceit is to be avoided. There are thousands who have been engaged in this business for years who are still second or third grade dressmakers, and the main cause of their incompetency is their overwhelming conceit. They seem to imagine that they know all that there is to be known in their business and therefore make but very little effort to learn or improve on their old time methods of work.

3rd. **STUDY THE BEST METHODS OF DEALING WITH CUSTOMERS.** Many simply manage to exist while they should rank among the first modistes of the land and win great prosperity, simply by mismanagement in dealings with their patrons.

4th. **PRICES.** If you do poor work you should only expect a poor price. If you do good work you have a right to receive good prices. If you do fine work you should then demand high prices, and the finer the work the higher prices you should receive. There is no such thing as extortionate prices in dressmaking providing the quality of your work and the reputation you have established as an artist in your line are in harmony with your prices. Abundance of work is usually associated with high prices. Find the person in your town that charges the most and you will probably find the one that has the most to do. Find the modiste or ladies' tailor in any city that demands the highest price and you will find the one who has the largest business. Find the person whose charges are larger than any other in this country and you will find the person that does more business than any other person in America and the one who charges more than any other in the world probably has the largest business in the world. The inventors of the **LADIES' TAILOR SYSTEM** believe that you have a perfect right to obtain every dollar you possibly can for your work providing that your prices are uniform and that you treat all your patrons alike.

Never allow customers to set their price on your work. That is your business and you must manage your own business or you will soon have no business to manage. Never allow customers to get work done at reduced prices because of the great influence they assume to have and which they promise to turn in your favor. The best possible influence you can have is to establish a reputation for doing fine work. Perfectly fitting and well made dresses have an influence wherever they move that cannot fail to bring you increased patronage. Beware of that class of friends who want you to do work for them cheaper than for others because they are your friends. The more friends you have of this kind the worse off you will be. It is a poor rule that does not work both ways. If their friendship is sincere why should they not say, “I am one of your friends, I know that you earn your money by your business and labor and I will therefore pay you a little more than I would others for the same work.” Always endeavor to give a prospective customer all the information she desires about the garment wanted before you give your price.

5th. **CREDIT.** In our judgment the only persons that should do a credit business are those who have sufficient capital to meet all current expenses and fill their customer's orders for several months without payment and who have a class of wealthy patrons who are perfectly responsible. All others should do only a strictly cash business and not allow a single dress to be delivered until paid for. It is better to lose customers than to be working for nothing, which all who do a credit business will sometimes have to do. You cannot earn a living, meet current expenses or pay your employes fair wages on promises.

THE LADIES' TAILOR SYSTEM.

6th. KEEP ORDER IN YOUR WORK-ROOM. This is a good motto and quite necessary in establishing a good business.

7th. NEVER FAIL TO WAIT ON YOUR PATRONS YOURSELF IF POSSIBLE.

8th. CORRECT MISTAKES FOR CUSTOMERS if made by yourself or employes promptly.

9th. TREAT YOUR SEWING GIRLS AND ALL EMPLOYEES KINDLY AND GENEROUSLY but be exacting in having them attend to their work promptly, having their work done as directed and their time well employed. Not one in a thousand will thank you for allowing them to disobey your instructions, to shirk their work or neglect their duty, but on the contrary will love and esteem you if they know that while they are treated with consideration and kindness that they must do their duty.

10th. IF IT IS POSSIBLE HAVE REGULAR HOURS FOR BUSINESS AND NEVER WORK AT NIGHT. It has been proven again and again that those who do this accomplish more work in ten hours than those who try to work day and night.

11th. IN TAKING MEASURES BE DELIBERATE, EXCEEDINGLY CAREFUL AND ACCURATE both in obtaining the measure and writing it in your measure book. Great care in this preliminary part of the work will not only save a great deal of time and annoyance but will give your patrons greater satisfaction and have a tendency always to build up your business. Much annoyance, loss of time and money would often be avoided if all instructions were written clearly when the orders are taken, then if a customer changes her mind or is in anyway displeased the written instructions are at hand to show just what was ordered, and if changes are desired a reasonable price could be expected for making them.

12th. BE PROGRESSIVE, KEEP UP WITH THE TIMES. The ever varying changes in fashions and the introduction of novelties in the cutting and making of ladies' garments, afford one a splendid opportunity to excel, and the one who will constantly study her business and be prepared to give her patrons the very latest styles and novelties accompanied with good work will be sure to do so. It is so easy to get in the habit of always doing work in one regular way that many fall into it and thus become old foggy dressmakers and sacrifice much business that they could otherwise control.

IMPORTANT TO BEGINNERS.

The demand of our day is skilled labor, and this will always command a high price. The bright reward of success can be obtained by any young woman of ordinary intelligence who will commence with a definite object in view and who will sit down and seriously study each lesson. There are many who simply learn to make a draft of a plain basque by this System in three or four lessons, and others who simply learn the plain basque from printed instructions, and afterwards win a fair measure of success, but if even three or six months time were required to master this System thoroughly the results would amply repay the student for her time and labor. If you wish to become an expert in the science of cutting so that you can take a position as forewoman or cutter or start in business for yourself you must begin at the beginning and go on step by step until every detail in our first instruction book is mastered. All knowledge apart from this is uncertain, unsatisfactory and superficial. The only difficulty in mastering all the details of instructions in this Complete Instructor will be found in the want of knowledge of primary lessons given in our first instruction book; therefore the student should take no step forward until each lesson preceding it has been thoroughly understood. The more thoroughly the first simple lessons are learned the more perfect will the student become in the science of dresscutting. It may take a day, a week or a month, but it will be time well spent, for without the knowledge of the first lessons the finest success cannot attend your studies. Therefore the thorough mastery of the plain lessons given in our instruction drafts is not only important but ABSOLUTELY NECESSARY. We would therefore advise the beginner not only to learn to make the plain drafting but to spend her spare time in practice until able to make the plain draftings quickly and accurately.

FRENCH BIAS BASQUE WITH STRAIGHT FRONT.

Fig. 1.

N. B.—Remember always that you must refer to the Life-sized Instruction Drafts for numbers of lines or dots not found on diagrams given in this book.

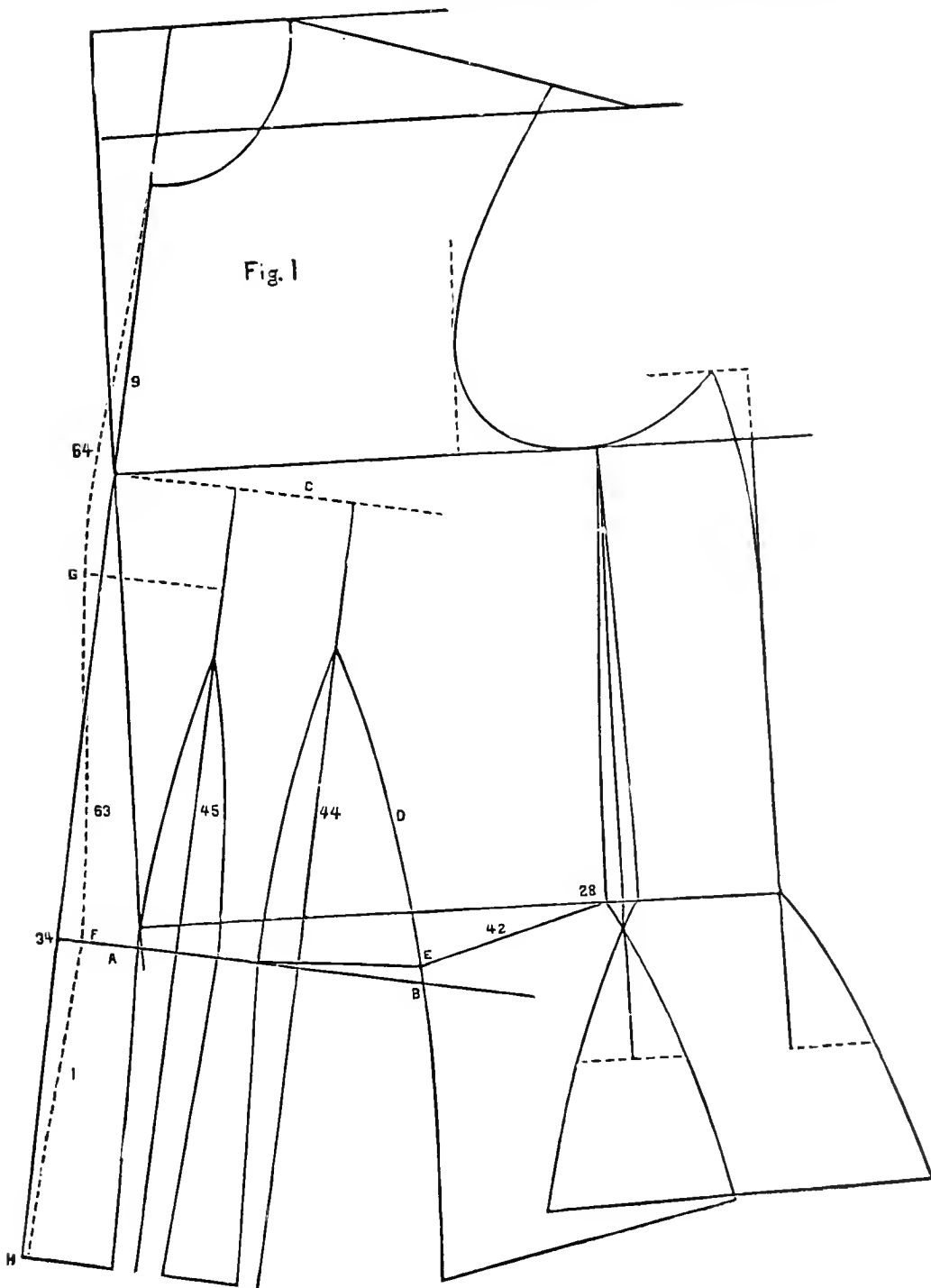

Is drafted the same as plain basque, with the following exceptions:

1. Draw line 1 4 inches from edge of paper.
2. Continue line 9 down to bottom of basque.
3. Make dot 34 on line 9 instead of line 1.
4. Draw line A from dot 34 square with line 9.
5. Make the dots for darts on line A in the same manner as on line 35 in instruction draft.
6. Make dot B on line A the same distance from dot 40 that line 1 is from dot 34.
7. Draw line C square with line 9.
8. Draw lines 44 and 45 through center of darts square with line C.
9. Draw the darts the same as in instruction draft with the exception of line D which is drafted with dart curve from top of dart across dot B to bottom of basque. The bias dart should be made $\frac{1}{2}$ inch higher than height of dart measure.
10. Make dot E the same distance from top of back dart that dot 39 is from top of dart.
11. Make new waist line from dot 39 to dot E.
12. Draw line 42 from dot E to dot 28.

FRENCH BIAS BASQUE WITH FRENCH FRONT.

Fig. 1.

Is made as illustrated by dotted lines 64, 63 and I in Fig. 1.

1. Make dot F $\frac{1}{4}$ inch inside of dot 34 on line A.
2. Make dot G the same as dot 62 in instruction draft.
3. Draw curved lines for front the same, as lines 63 and 64 in instruction draft.
4. The darts should be set back the same distance that dot F is from dot 34, and $\frac{1}{4}$ inch must be deducted from size of front dart.
5. Make dot H on line 9 6 inches below dot 34.
6. Draw line I from dot F to dot H.

FRENCH BIAS BASQUE WITH TWO UNDER-ARM PIECES.

Fig. 2.

Is drafted the same as Fig. 1, with the following exceptions:

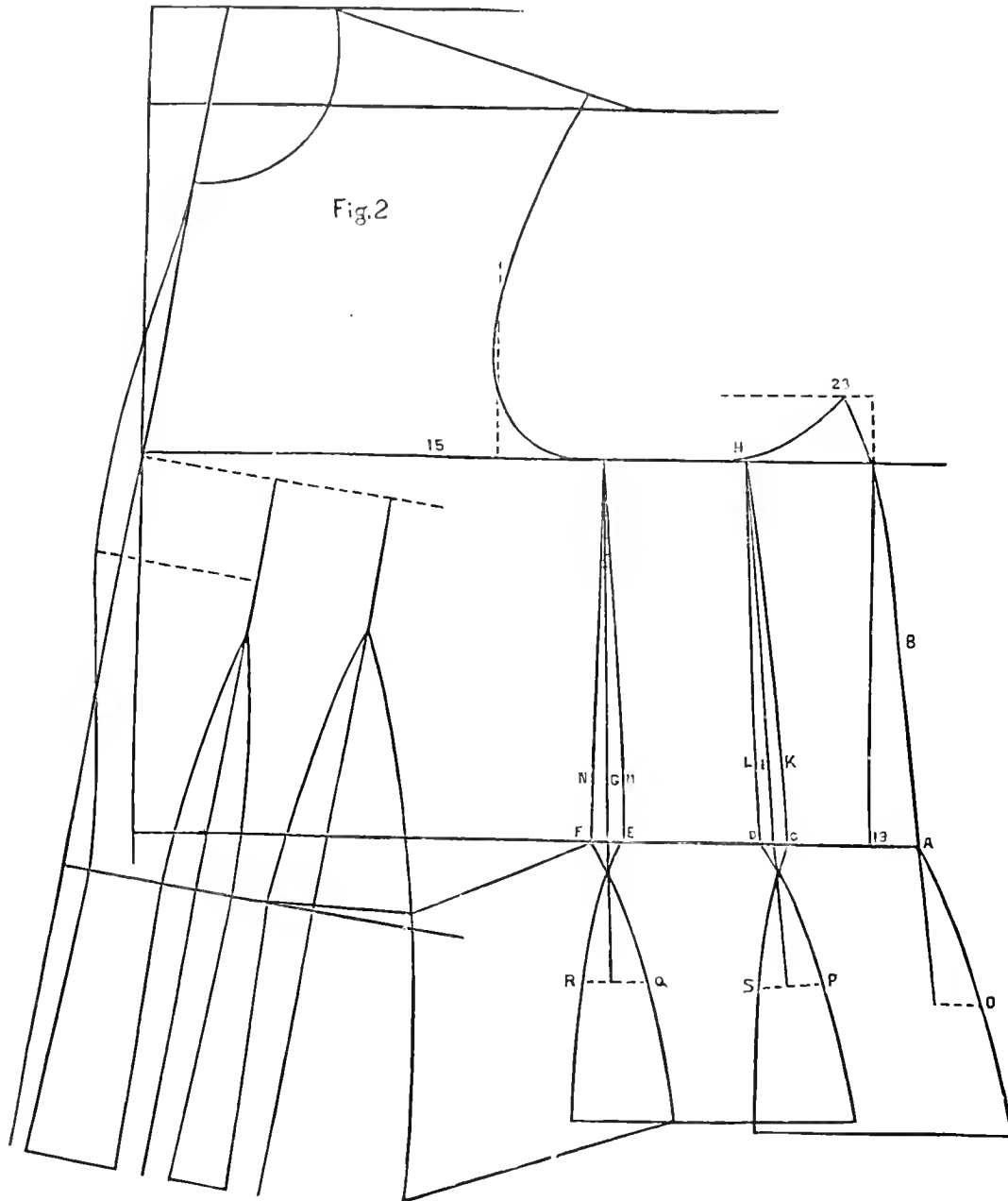

1. The back piece at waist should be about 1 inch wide.
2. Side-body at waist should be from 2 to 2½ inches wide.
3. In the front make dot A 1 inch outside from dot 19.
4. Draw line B from dot 23 across dot A to a point 3 inches below waist line using sleeve curve, point S at dot 23 (turn System over).
5. Make dot C the width of side-body in back from dot A.
6. Make dot D ½ inch from dot C.
7. Make dot E the width of side-body in back from dot D.
8. Make dot F ½ inch from dot E.
9. Draw line G through center of front under-arm dart to a point three inches below waist line square with line 15.
10. Make dot H the width of side-body in back from top of line G on line 15.
11. Draw line I from dot H through the center of back under-arm dart and to a point 3 inches below waist line.
12. Lines K, L, M and N are drawn the same as lines 30 and 31 in instruction draft.
13. Make dot O 1 inch from end of line B.
14. Make dot P 1 inch from end of line I.
15. Make dot Q 1 inch from end of line G.
16. Make dot R ¼ inch from end of line G.
17. Make dot S ¼ inch from end of line I.
18. Draw skirt lines in the same manner as in instruction draft.

ADDRESS ALL COMMUNICATIONS TO HUGHES & STOREY, ST. LOUIS, MO.

THE LADIES' TAILOR SYSTEM.

French bias basque with two under-arm pieces can be used for ladies of medium size, but is usually preferred for larger forms.

Fig. 2 is therefore drafted to the same measures as in instruction drafts, except that the scye is 11, bust 34, waist 31, chest 15, width of back 13, length of front $20\frac{1}{2}$, under-arm is 8, and shoulder $5\frac{3}{4}$.

PARISIAN DARTLESS BASQUE.

Fig. 3.

Is made the same as instruction draft, with the following exceptions :

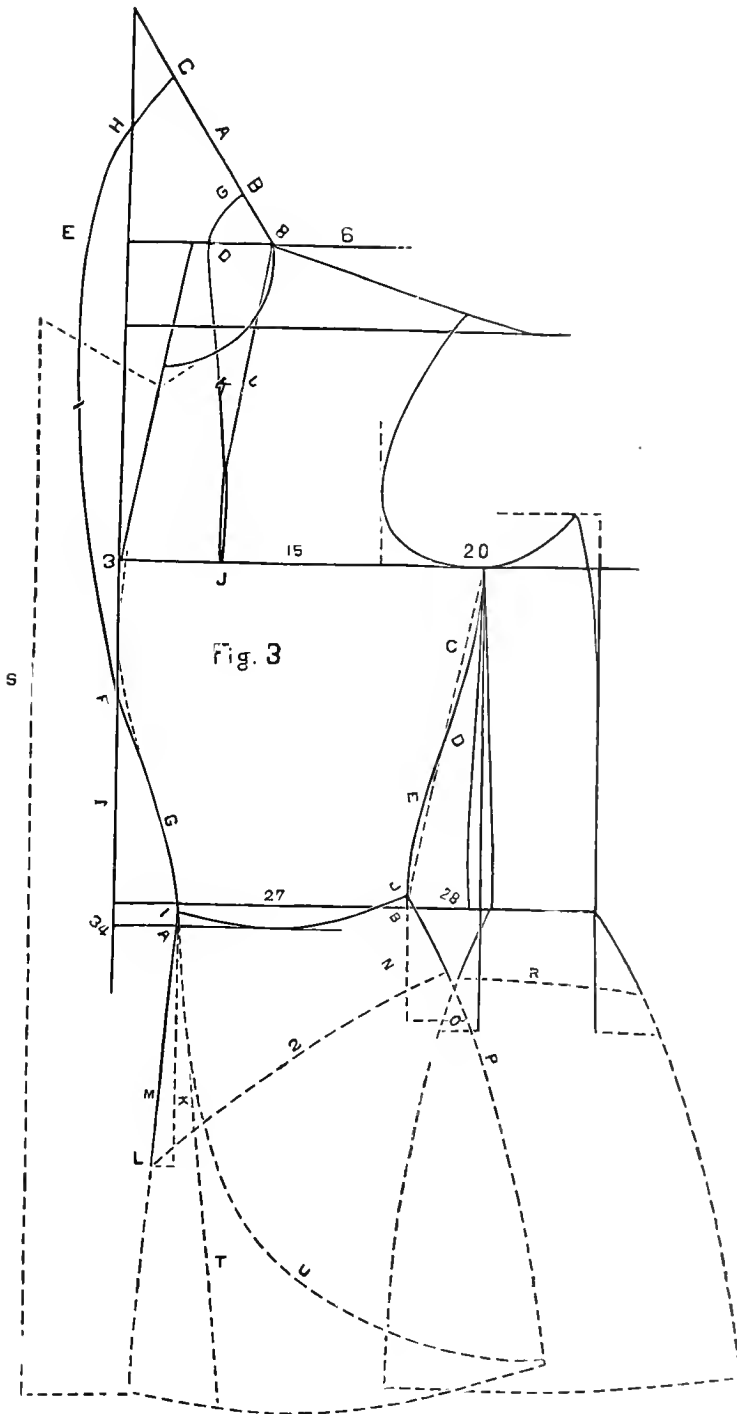

1. Make dot A $\frac{1}{4}$ inch less than the size of front dart from dot 34.
2. Make dot B $\frac{1}{4}$ inch more than the size of back dart from dot 28.
3. Draw dotted line C from dot 20 to dot B.
4. Make dot D in the center of line C.
5. Draw line E with sleeve curve (turn system over), place point S at dot 20 and draw line E to dot D, then place point S at dot B and continue line E to dot B.
6. Make dot F the height of first dart measure above dot 34 on line 1.
7. Place point S at dot A and draw line G to dot F, then shape the front as illustrated by dotted lines in Fig. 3 with dart curve.
8. Make dot I on line G the height of front dart measure below dot F.
9. Make dot J on line E the under arm measure below dot 20.
10. Shape waist line with dart curve as shown in Fig. 3.
11. Draw dotted line K square from dot A six inches long.
12. Make dot L $\frac{1}{2}$ inch from end of line K.
13. Draw line M from dot I to dot L straight.
14. Draw dotted line N 3 inches long from dot B square with line 27.
15. Make dot O $1\frac{3}{4}$ inches from end of line N.
16. Draw line P from dot J across dot O, point F at dot J.

Lower part of basque is shaped as illustrated by dotted lines Q and R.

DOUBLE BREASTED COAT.

Fig. 3.

All outside garments, Cloaks, Mantles, Ulsters. Waterproofs, etc., should be made one inch

larger (in neck, bust, waist, hip, arms-eye, elbow and hand) than for plain basques.

For double breasted garments draw dotted line S 2 inches outside of line 1 as illustrated in Fig. 3.

ADDRESS ALL COMMUNICATIONS TO HUGHES & STOREY, ST. LOUIS, MO.

THE LADIES' TAILOR SYSTEM.

DARTLESS COAT—TIGHT FITTING.

Fig. 3.

Extend skirt lines of basque from 9 to 18 inches long as illustrated by dotted lines in Fig. 3. Lapel and collar is made the same as in Fig. 25.

DARTLESS HALF FITTING COAT.

Fig. 3.

Is made the same as dartless coat with the following exceptions: Omit lines G and M, use line 1 for center of front as shown in Fig. 3.

DARTLESS THREE-QUARTER COAT.

Fig. 3.

Is made the same as dartless half fitting coat with the following exceptions: Use dotted line S the same as for double breasted coat instead of line 1 as illustrated in Fig. 3.

BLAZER.

Fig. 3.

Make same as dartless coat. Skirt in front can be made square or cutaway as shown by dotted lines T and U. This garment is buttoned only at the bust. Shawl collar can be added as in Fig. 3 instead of lapel and collar if preferred.

BACK FOR COAT OR JACKET.

Fig. 4.

Draft the same as in instruction draft with the following exceptions: The skirt lines are made from 9 to 18 inches long or length desired for coat skirt, as shown in Fig. 4.

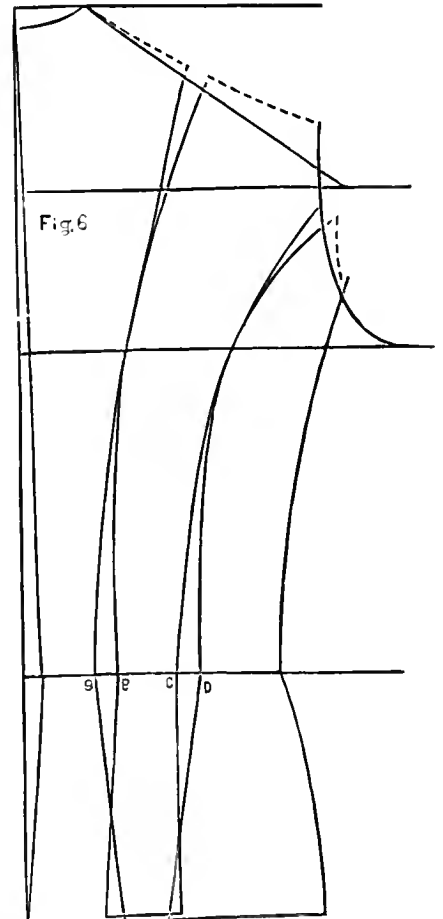
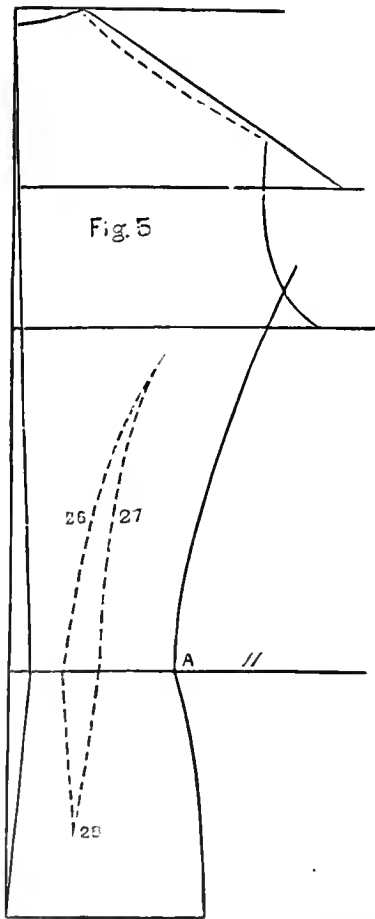
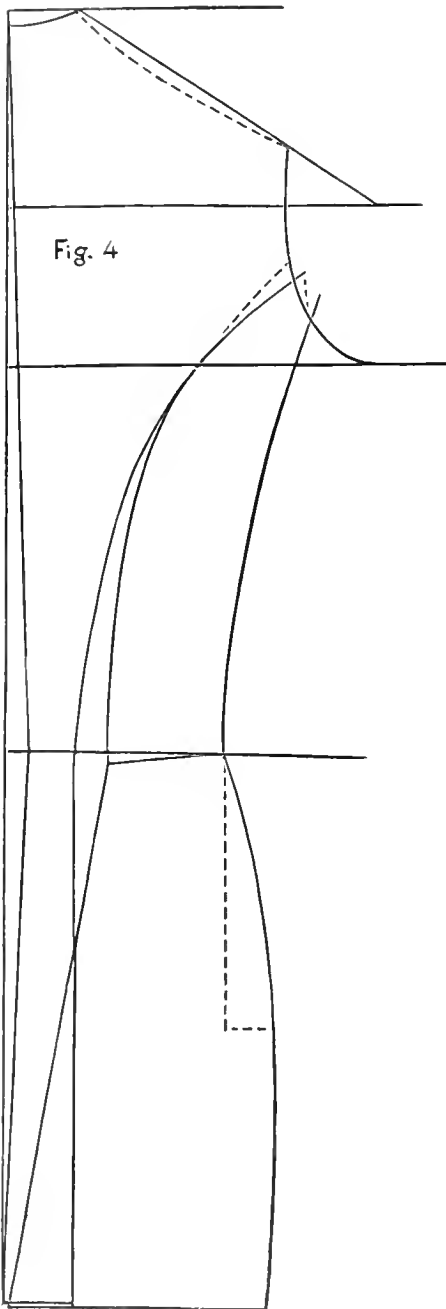

THE FRENCH BACK.

Fig. 5.

Is drafted the same as the instruction drafts, with the following exceptions: 1st. Make dot A $\frac{3}{4}$ inch inside of

THE LADIES' TAILOR SYSTEM.

dot 11. 2nd. French back can be drafted with a dart by drawing back side-form lines the same as instruction draft and leaving out the part above the junction of lines 26 and 27 and the lines below dot 23 as shown by dotted lines in Fig. 5.

HOW TO DRAFT BACK IN SIX PIECES.

Fig. 6.

Draft the same as in instruction draft, with the following exceptions:

1. Make dot B $\frac{1}{2}$ inch from dot 9.
2. Make dot C $1\frac{1}{2}$ inches from dot B.
3. Make dot D $\frac{1}{2}$ inch from dot C.
4. Make a $\frac{1}{2}$ inch dart in center of shoulder.
5. Make a $\frac{1}{2}$ inch dart in center of arm-hole.
6. Draw side-form lines and darts shaping them with dart curve according to taste.
7. Draw skirt lines as illustrated in Fig. 6.

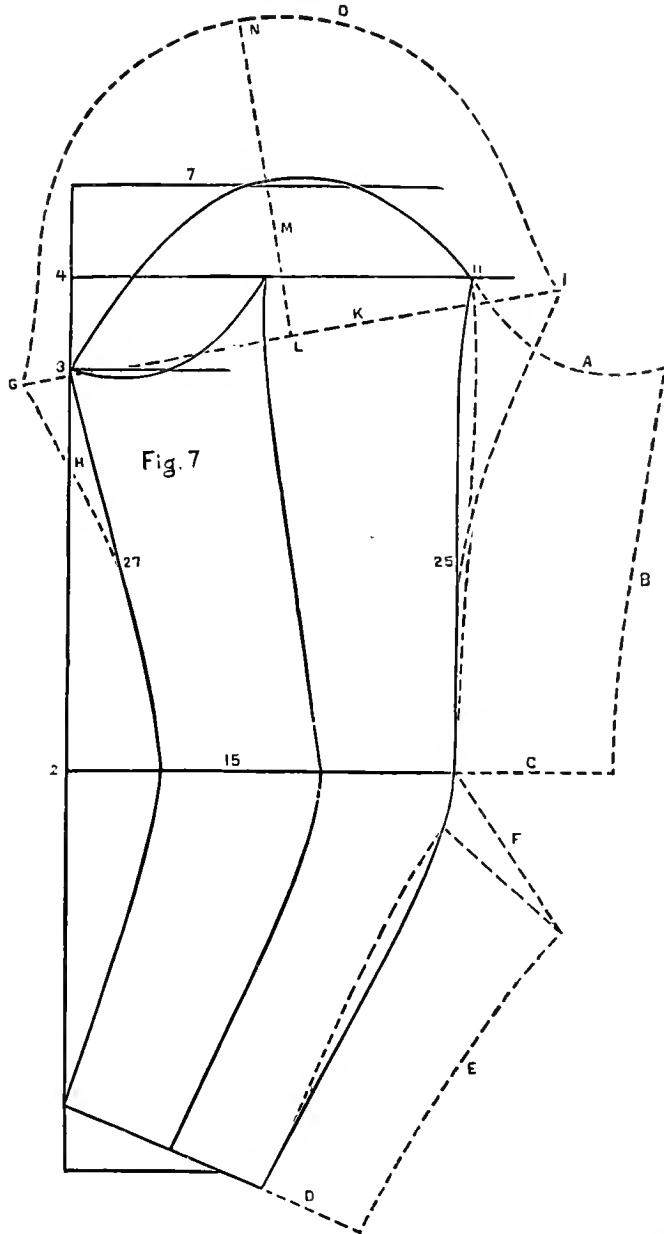

FULL DRESS SLEEVE.

Fig. 7.

1. Make dot G 1 inch from dot 3.
2. Draw line H from dot G to center of line 27 (use dart curve).
3. Make dot I 2 inches outside of dot 11.
4. Draw line J from dot I to center of line 25 (use dart curve).
5. Draw line K from dot I to dot G straight.
6. Make dot L in center of line K.
7. Draw line M from dot L square with line K.
8. Make dot N $3\frac{1}{2}$ inches from line 7.
9. Draw line O, shaping it as illustrated by dotted lines in Fig. 7.

ONE SEAM SLEEVE.

Fig. 7.

One seam sleeve is one of the most comfortable sleeves worn and for sleeves made from light fabrics, it is one of the very best because there are no seams to show through the goods when ironed.

1. Trace out the upper part of sleeve.
2. Trace out the under-arm part of sleeve on drafting paper and cut it out on the tracing lines.

ADDRESS ALL COMMUNICATIONS TO HUGHES & STOREY, ST. LOUIS, MO.

THE LADIES' TAILOR SYSTEM.

3. Cut the under-arm piece in two at elbow on line 15, then place the upper part of under-arm piece so that it will join the upper at elbow and arms-eye, and trace lines A, B and C as shown in Fig. 7.

4. Join the lower part of under-arm piece as illustrated by dotted lines, then trace lines D and E and trace straight line F from end of line E to elbow at dot 19.

15. The space between line F and line C is cut out as a dart, allowing small seams.

BISHOP SLEEVE.

Fig. 8.

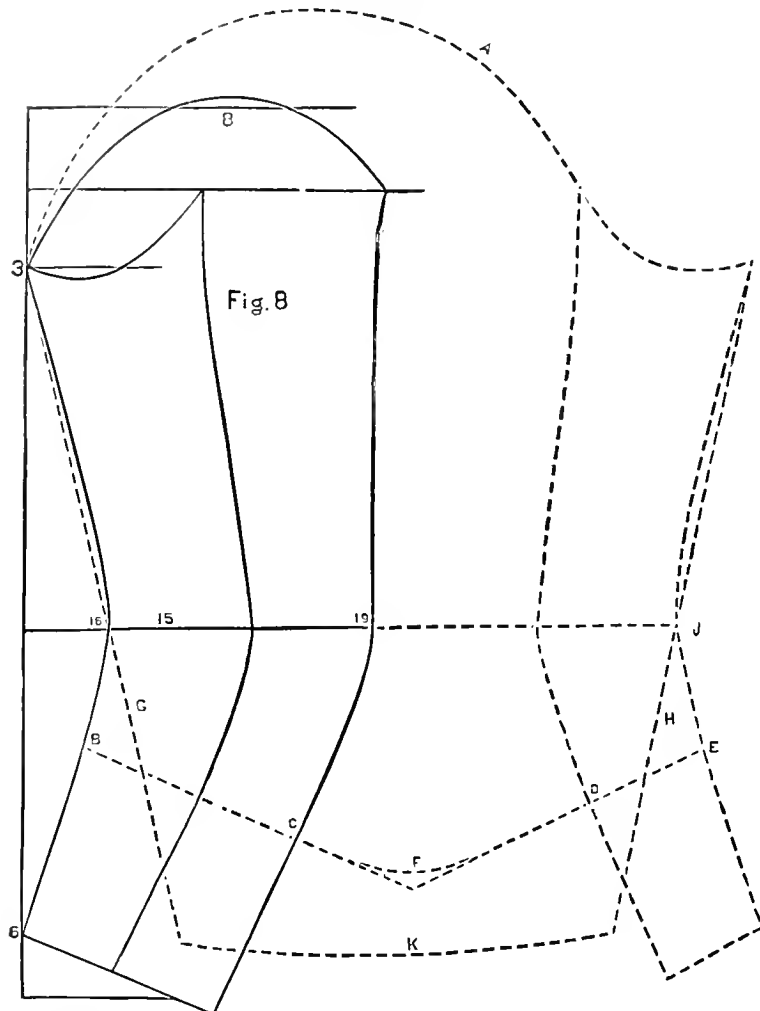

1. Make plain sleeve drafting.
2. Extend line 15 as illustrated in Fig. 8.
3. Trace out the under-arm piece on drafting paper and cut it out on tracing lines.
4. Place the elbow of under-arm piece on line 15 from 3 to 5 inches from dot 19.
5. Draw line A shaping it so that it will be about 2 inches above dot 8 as illustrated in Fig. 8.
6. For cuff trace line F from B to C and from D to E making the cuff any length desired from the hand (allowing seams).
7. For the upper part of sleeve trace line F from B to E and the remainder of outside lines of sleeves allowing seams.

For draped sleeve allow about $1\frac{1}{2}$ inches on upper part below line F.

SHIRT SLEEVE.

Fig. 8.

Draft same as Bishop Sleeve with the following exceptions as shown in Fig. 8.

1. Trace straight line G from dot 3 across dot 16 the same distance from dot 3 that dot 6 is from dot 3.
2. Trace straight line H from dot I across dot J the same length as line G.
3. Draw line K from end of line G to end of line H, use dart curve.
4. In cutting out shirt sleeve place line H parallel with straight edge of goods.

ADDRESS ALL COMMUNICATIONS TO HUGHES & STOREY, ST. LOUIS, MO.

THE LADIES' TAILOR SYSTEM.

BELL SLEEVE.

Fig. 9.

The dotted lines A, B, in Fig. 9 illustrate clearly how to draw Bell Sleeve.

FULL DRESS BELL SLEEVE.

Fig. 9.

Is made the same as the Bell Sleeve in Fig. 9 with the exception that the upper part is drafted the same as in the Full Dress Sleeve in Fig. 7.

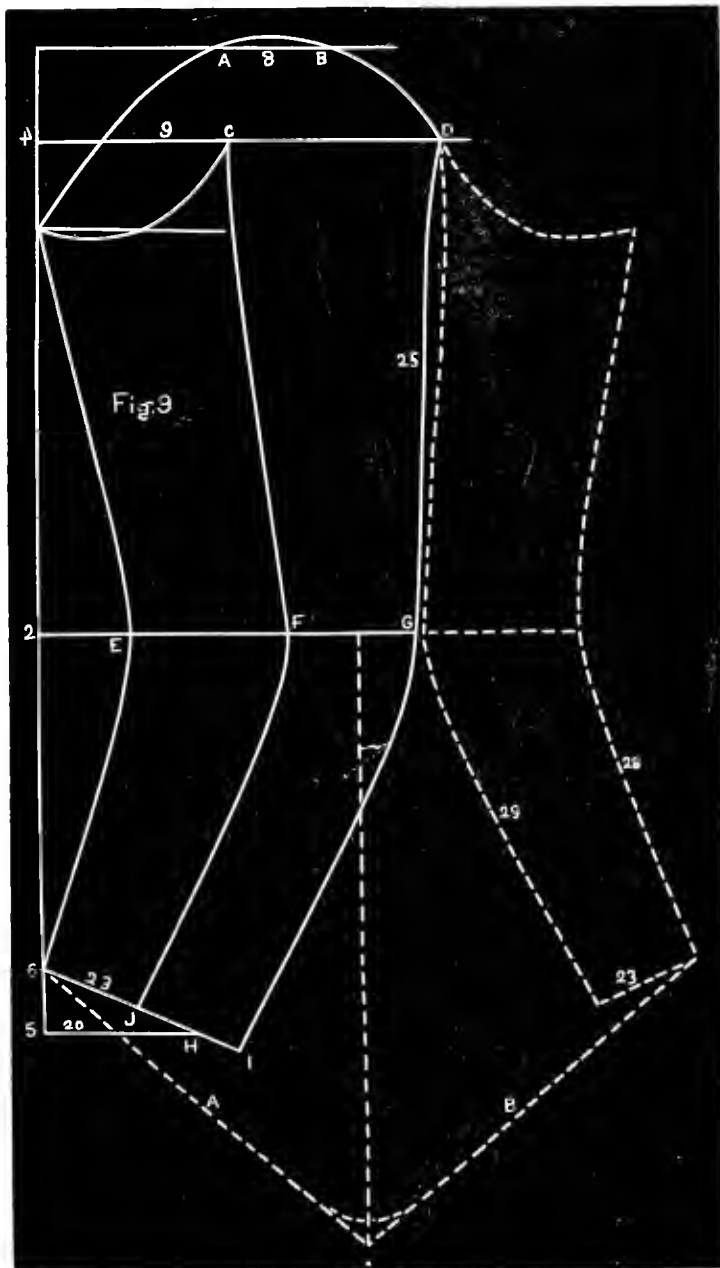

THE LADIES' FAVORITE SLEEVE.

Fig. 9.

Draft same as in instruction draft, with the following exceptions:

1. Make dot A 1 inch inside of dot 8.
2. Make dot B 1 inch outside of dot 8.
3. Make dot C $\frac{3}{4}$ inch less than $\frac{1}{2}$ of arms-eye measure from dot 4 on line 9.
4. Make dot D $4\frac{1}{2}$ inches from dot C.
5. Make dot E 2 inches from dot 2.
6. Make dot F $1\frac{1}{2}$ inches inside of dot 17.
7. Make dot G $1\frac{1}{2}$ inches outside of dot 17.
8. Make dot H $\frac{1}{2}$ of hand measure from dot 5 on line 20.
9. Draw line 23 from dot 6 across dot H.
10. Make dot I on line 23 1 inch outside of dot H.
11. Make dot J on line 23 $1\frac{1}{2}$ inches inside of dot H and draft the remainder of the sleeve in the same manner as in instruction draft.

TIGHT FITTING SLEEVE.

Fig. 9.

Cut out in one piece with two seams from elbow to wrist.

The simplest and easiest way to make this sleeve is as follows:

1. Make sleeve same as in instruction draft, or the same as the Ladies' Favorite in Fig. 9.
2. Fold the lining double and trace out the upper part of sleeve except line 25.
3. Trace out the under part of sleeve on drafting paper and cut it out on the tracing lines, place this pattern as shown in Fig. 9 so that the points at arms-eye and elbow will meet, then trace lines 28, 23 and 29, and cut out sleeve allowing small seams everywhere.

ADDRESS ALL COMMUNICATIONS TO HUGHES & STOREY, ST. LOUIS, MO.

FRENCH TIGHT FITTING SLEEVE.

Fig. 10.

Is drafted the same as in instruction draft, with the following exceptions:

1. Make dot 16 2 inches from dot 2 instead of $1\frac{1}{2}$ inches as in instruction draft.
2. Make dot A 3 inches more than $\frac{1}{2}$ of arms-eye measure from dot 3.
3. Make dot B $\frac{1}{4}$ of arms-eye measure from dot A.
4. Make dot C $\frac{1}{4}$ of arms-eye measure from dot 3.
5. Make dot 22 $\frac{2}{3}$ of hand measure from dot 6 on line 20 and draw line 23 to it.
6. Make dot 24 in center of line 23.
7. Lines 25, 26, 27, 28, 29 and 30 are drawn perfectly straight.
8. The lines at elbow should be slightly rounded with arm curve, as seen in Fig. 10.

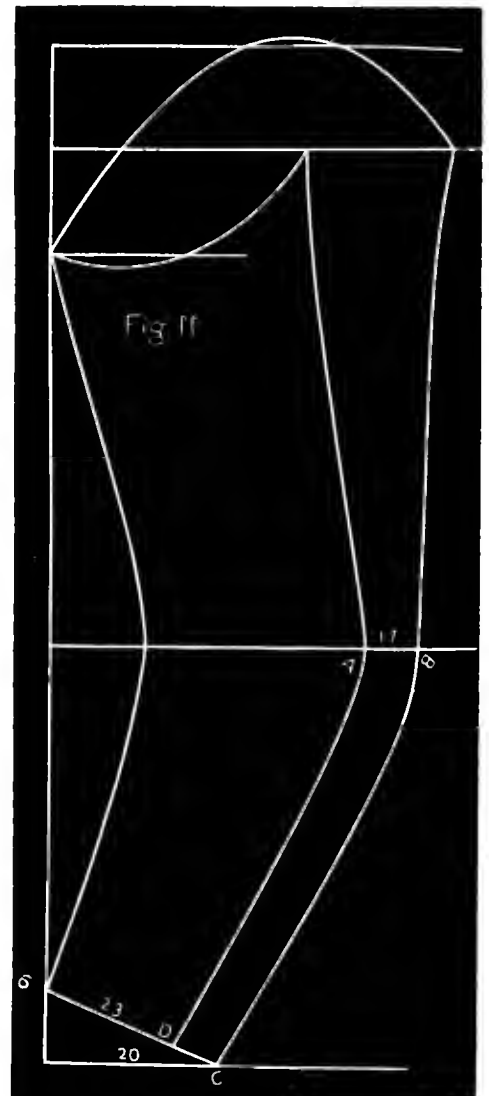
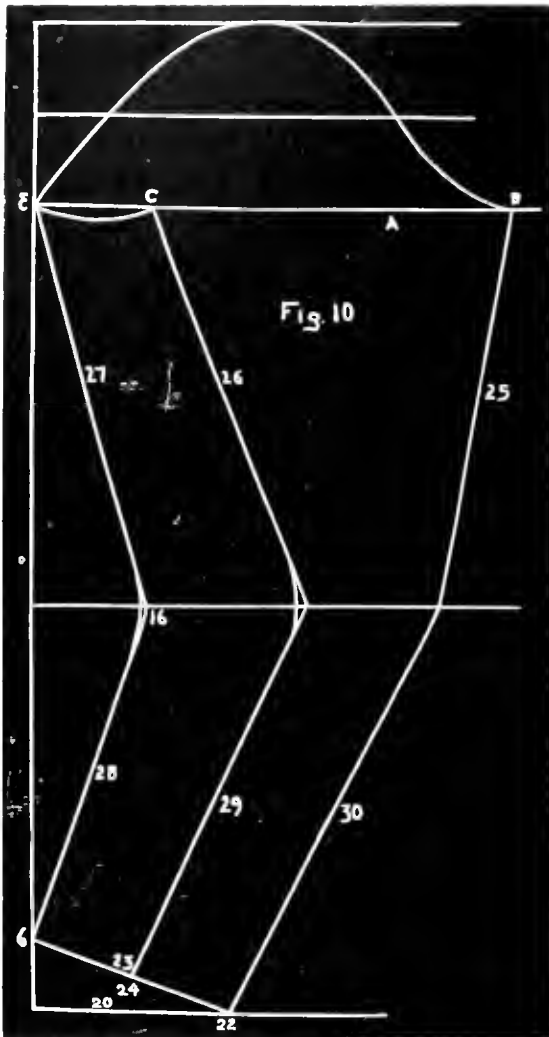

THE COAT SLEEVE.

Fig. 11.

Is drafted same as in instruction draft, with the following exceptions:

1. Make dot A $\frac{1}{2}$ inch inside of dot 17.
2. Make dot B $\frac{1}{2}$ inch outside of dot 17.
3. Make dot C on line 20 $\frac{1}{2}$ inch more than $\frac{1}{2}$ of hand measure from dot 6.
4. Make dot D 1 inch from dot C on line 23, then draw the remaining lines same as in instruction draft.

THE WORTH SKIRT.

Fig. 12.

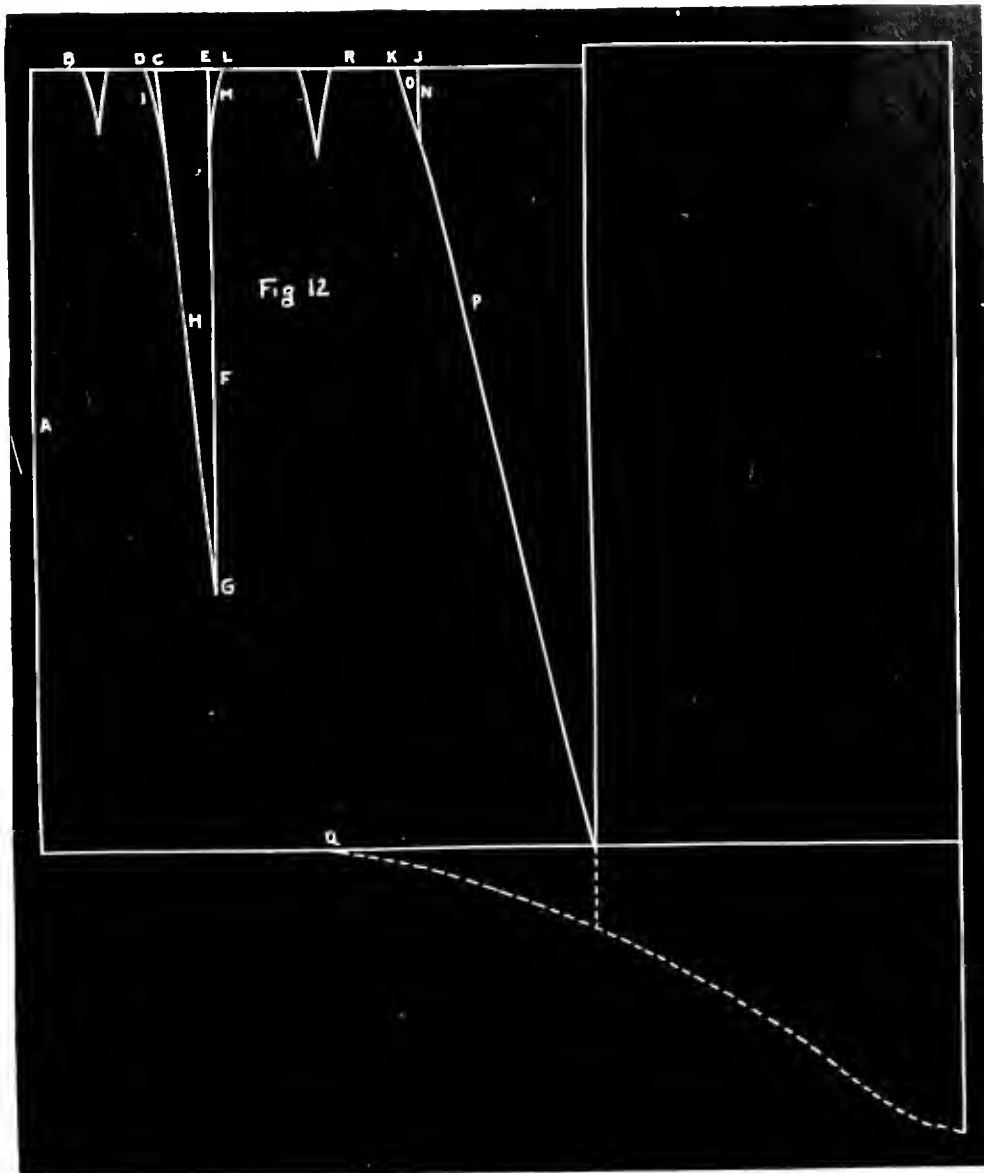

1. Draw line A the front skirt measure as shown in Fig. 12.
2. Draw line B square with top of line A.
3. Make dot C $\frac{1}{4}$ of waist measure from top of line A.
4. Make dot D 1 inch from dot C.
5. Make a 1-inch dart 2 inches from top of line A 3 inches in length.
6. Make dot E $2\frac{1}{2}$ inches from dot C.
7. Draw line F square with line B from dot E.
8. Measure from the waist to the knee and make dot G the amount of this measure on line F from dot E.
9. Draw line H straight from dot C to dot G.
10. Draw line I from dot D to line H with dart curve.
11. Place $\frac{1}{4}$ of waist measure at dot E and make dot J 2 inches less than $\frac{1}{2}$ of hip measure from dot E.
12. Make dot K 2 inches from dot J.
13. Make dot L 1 inch from dot E.
14. Draw line M from dot L to line F with dart curve.
15. Draw line N square with line B from dot J 6 inches long.
16. Draw line O from dot K to end of line N with dart curve.

ADDRESS ALL COMMUNICATIONS TO HUGHES & STOREY, ST. LOUIS, MO.

THE LADIES' TAILOR SYSTEM.

17. Draw line P straight from end of line O the length of skirt from dot K to a point from 27 to 30 inches from end of line A.
18. Draw line Q from end of line A to end of line P.
19. Place $\frac{1}{4}$ of waist measure less 2 inches at dot E and make dot R 1 inch less than $\frac{1}{2}$ waist.
20. Measure the space from dot R to dot K and you have the size of the dart. Place this dart 2 inches from dot E.

BELL SKIRT.

Fig. 13.

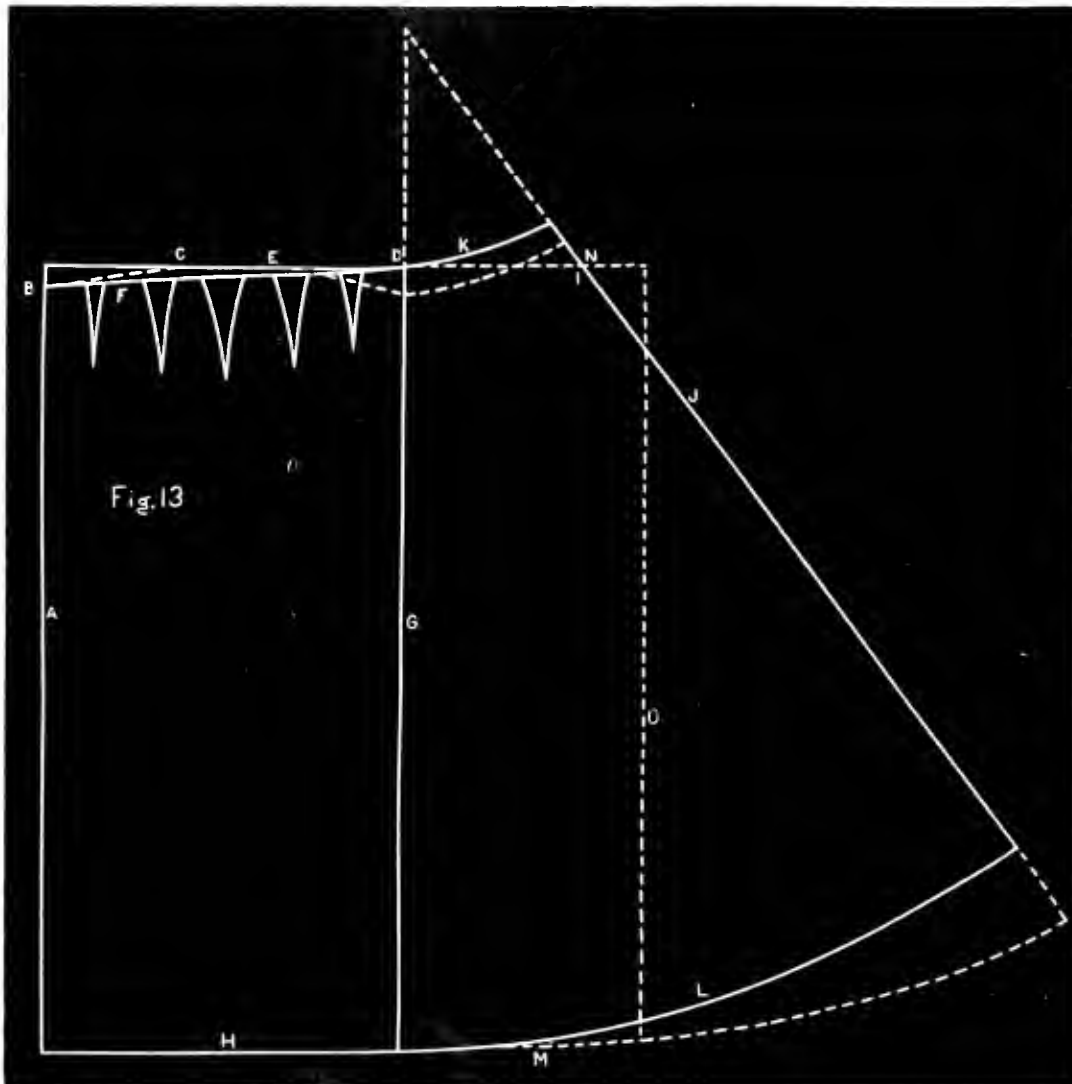

1. Draw line A 1 inch more than length of skirt measure as shown in Fig. 13.
2. Make dot B 1 inch from top of line A.
3. Draw line C square from top of line A.
4. Make dot D 2 inches less than $\frac{1}{2}$ of hip measure from top of line A.
5. Make dot E 1 inch less than $\frac{1}{2}$ of waist measure from top of line A.
6. Draw line F from dot B to dot D straight.
7. Measure the distance from dot E to dot D and you have the amount for darts. If the amount is 7 inches or more there should be five darts. If the amount is less than 7 inches take it out in three or four darts, dividing the darts so that the largest dart will come directly over the hip.
8. Draw line G square with line C from dot D the same length as line A and draw line H from end of line A to end of line G.
9. Make dot I 9 inches from dot D on line C.

10. Extend line G 12 inches above dot D.
 11. Draw line J from the end of line G across dot I to bottom of skirt.
 12. Sweep line K (with tape line) from dot D to line J, using top of line G as a pivot.
 13. Sweep line L from end of line G to line J, using top or line G as a pivot.
- Train can be added as illustrated by dotted lines.

When hips are very large and the side skirt measure is longer than front and back measure then waist line should be made as illustrated by dotted lines. When this is necessary the waist line is dropped from $\frac{1}{2}$ to 1 inch in front and back and rounded up over the hip.

FAN BACK SKIRT.

Fig. 13.

Is made the same as bell skirt except that lines K and L are extended 6 inches outside of line J and a new line J drawn across the ends of line K and L (more or less can be added according to the number or size of plaits or fullness wanted) as shown in Fig. 13.

ADDRESS ALL COMMUNICATIONS TO HUGHES & STOREY, ST. LOUIS, MO.

THE LADIES' TAILOR SYSTEM.

PLAIN ROUND SKIRT.

Fig. 13.

Is made the same as the bell skirt except that lines C and H are extended 12 inches outside of line G as illustrated by dotted lines M, N and O in Fig. 13.

UMBRELLA SKIRT.

Fig. 13.

Is made the same as bell skirt in Fig. 13 with the exceptions that more fullness is usually added in the center of the back both at waist and bottom of skirt.

SEVEN GORED SKIRT.

Fig. 14.

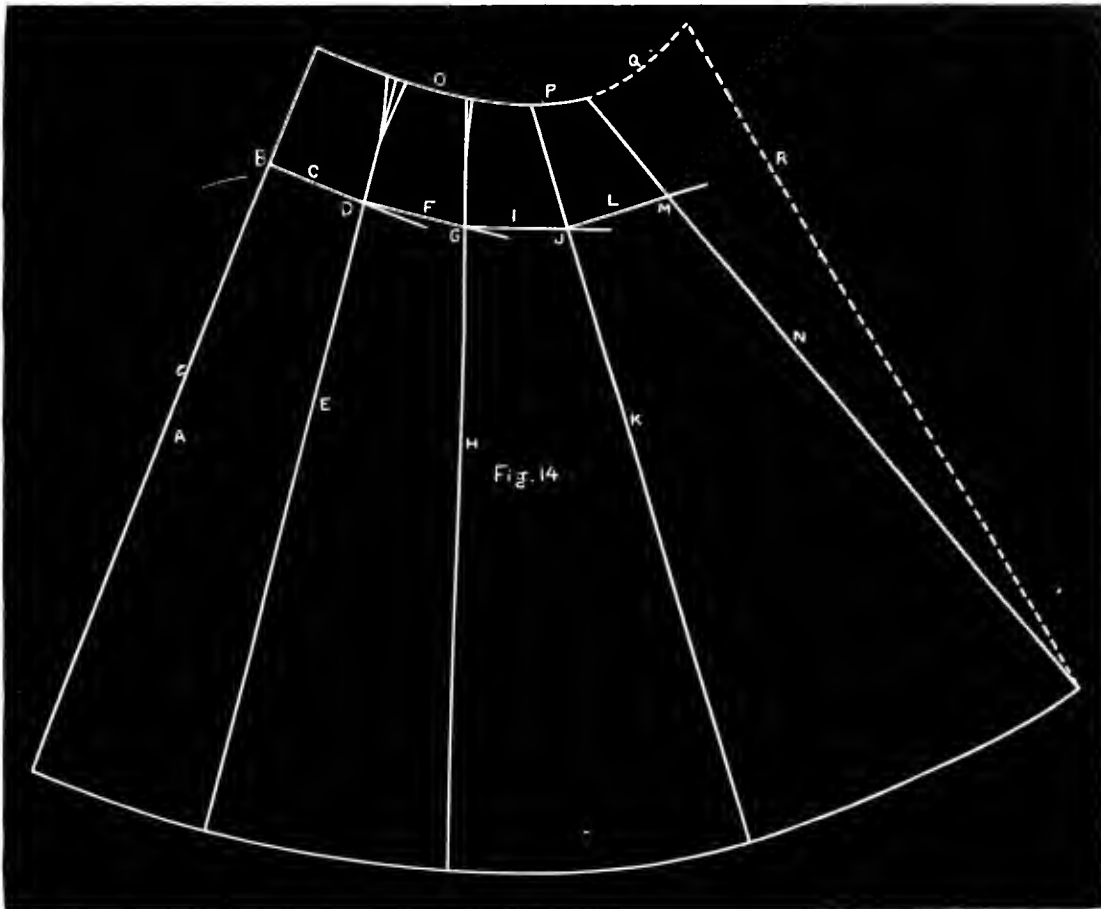

1. Draw line A the length of skirt, as shown in Fig. 14.
2. Make dot B 6 inches from top of line A.
3. Draw line C square with line A from dot B.
4. Make dot D $\frac{1}{8}$ of hip measure from dot B on line C.
5. Draw line E the length of skirt across dot D from a point 6 inches above dot D to a point 9 inches from lower end of line A.
6. Draw line F square with line E from dot D.
7. Make dot G $\frac{1}{8}$ of hip measure from dot D on line F.
8. Draw line H, same as line E, across dot G to a point 11 inches from the lower end of line E.
9. Draw line I square with line H from dot G.
10. Make dot J $\frac{1}{8}$ of hip measure from dot G on line I.
11. Draw line K, same as line E, across dot J to a point 13 inches from end of line H.
12. Draw line L square with line K from dot J.
13. Make dot M $\frac{1}{8}$ of hip measure from dot J on line L.
14. Draw line N, same as line E, across dot M to a point 15 inches from end of line K.
15. Draw line O, or waist line with dart curve, across the ends of lines A, E, H, K and N.
16. Make dot P on line O the waist measure in half inch figures from end of line A.
17. Measure the distance from dot P to end of line N, and you have the amount for darts.
18. Take out the amount for darts from end of lines E and H over largest part of the hip.
19. Shape the bottom of skirt, giving it a slight curve as illustrated in Fig. 14, and fullness at waist can be added as shown by dotted lines.

ADDRESS ALL COMMUNICATIONS TO HUGHES & STOREY, ST. LOUIS, MO.

THE STANDING COLLAR.

Fig. 15.

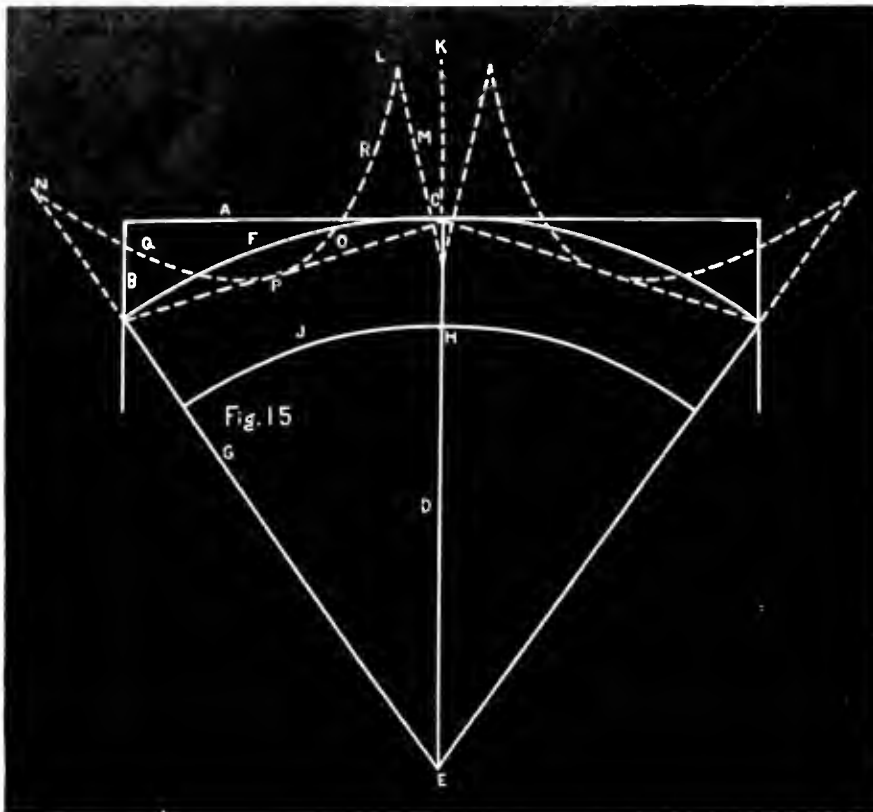

1. Draw lines A and B square with each other as in Fig. 15.
2. Make dot C 1 inch more than half of neck measure from end of line B.
3. Draw line D from dot C perfectly square with line A.
4. Make dot E the neck measure from dot C on line D.
5. Sweep line F from dot C to line B, using dot E as a pivot.
6. Draw line G from dot E to end of line F.
7. Make dot H $2\frac{1}{4}$ inches from dot C on line D or the desired width of collar.
8. Sweep line J from dot H to line G, using dot E as a pivot.

The above instructions give one half of the plain round collar.

POINTED COLLAR.

Fig. 15.

1. Extend line D and make dot K $3\frac{1}{2}$ inches above dot C as given in Fig. 15.
2. Make dot L one inch from dot K.

3. Draw line M from dot L to a point half way between dot C and dot H on line D.
4. Extend line G and make dot N $3\frac{1}{2}$ inches from end of line F.
5. Draw line O from junctions of lines F and G to dot C.
6. Make dot P in center of line O.
7. Draw line Q with arm curve, point D on System at dot P to dot N.
8. Turn system over and draw line R from dot P to dot L in the same manner as line Q.

The above instructions give one half of collar.

ROLL COLLAR.

Fig. 16.

1. Draw lines A and B square with each other as shown in Fig. 16.
2. Make dot C on line B one-half of neck measure from end of line A.
3. Make dot D on line A one-half of neck measure from end of line B.
4. Draw line E from dot D square with line A.
5. Make dot F on line E one-half of neck measure from dot D.

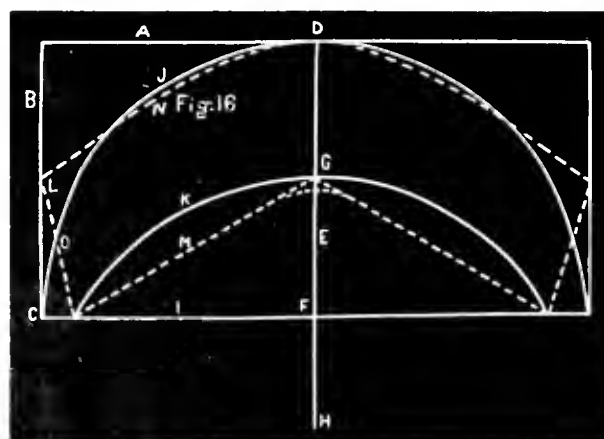

6. Make dot G on line E half way between dots D and E.
7. Make dot H on line E one-half of neck measure from dot G.
8. Draw line I from dot F to dot C.
9. Sweep line J from dot C to dot D, using dot F as a pivot.
10. Sweep line K from dot G to line I, using dot H as a pivot.

The above instructions give one-half of collar.

Another very pretty style of collar can be made as illustrated by dotted lines in Fig. 16.

1. Make dot L on line B 3 inches above dot C.
2. Draw line M straight from dot G to end of line K.
3. Draw line N from dot D to dot L (place point E at dot D turn System over).
4. Draw line O from end of line M to dot L.

THE LADIES' TAILOR SYSTEM.

TURN DOWN COLLAR.

Fig. 17.

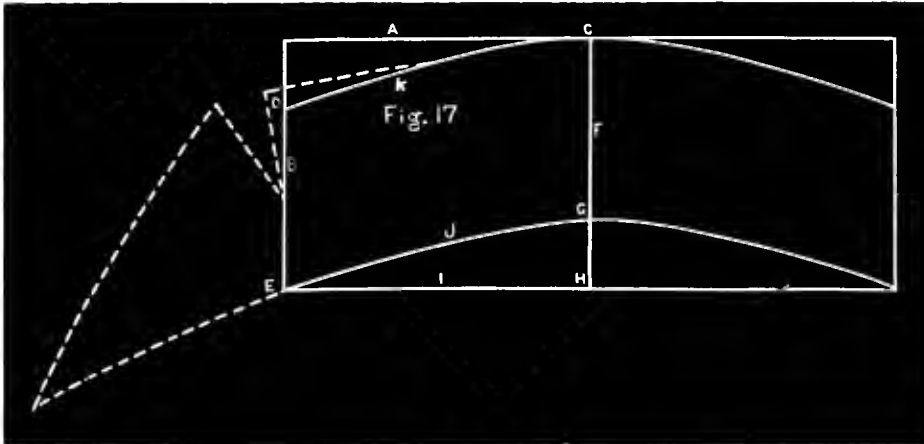

1. Draw lines A and B square with each other as in Fig. 17.

2. Make dot C $\frac{3}{4}$ inch more than half of neck measure from end of line B.

3. Make dot D $1\frac{1}{2}$ inches from end of line A.

4. Make dot E four inches from dot D on line B (or the desired width of collar).

5. Draw line F square with line A from dot C.

6. Make dot G the width of collar from dot C on line F.

7. Make dot H $1\frac{1}{2}$ inches from dot G on line F.

8. Draw line I from dot E to dot H.

9. Draw line J from dot E to dot G point F on System at dot G (turn system over).

10. Draw line K same as line J from dot C to dot D.

This gives half of the collar, the remaining half can be drafted in the same manner.

COLLAR AND LAPEL TOGETHER.

Fig. 17.

This collar is made as illustrated by dotted lines in Fig. 17. Extend the point of collar from 3 to 5 inches from dot E or length desired.

SHAWL COLLAR.

Fig. 3.

Shawl collar can be worn on this basque, or any other style of waist if desired, but it is usually worn on ladies' coats or outside garments. It is drafted as follows, as shown in Fig. 3:

1. Continue line 1 6 inches above line 6.

2. Draw line A from top of line 1 to dot 8.

3. Make dot B 2 inches from dot 8 on line A.

4. Make dot C $3\frac{1}{2}$ inches (or the width desired for collar), from dot B.

5. Make dot D $1\frac{1}{2}$ inches from dot 8 on line 6.

6. Make dot E 3 inches from dot D (or the width desired).

7. Draw line G with neck curve from dot B to dot D.

8. Make dot H $3\frac{1}{4}$ inches from center of line G to a point half way between dots C and E.

9. Draw line I with dart curve (turn System over), touching dots H, E and F.

10. Continue line I to dot C (use arm curve).

11. Make dot J 2 inches from dot 3 on line 15.

12. Draw line K from dot J to dot D (using sleeve curve), point T at dot J.

13. Draw line L same as line K (turn System over).

The space between lines K and L is sewed up as a dart, and the collar is turned back over it.

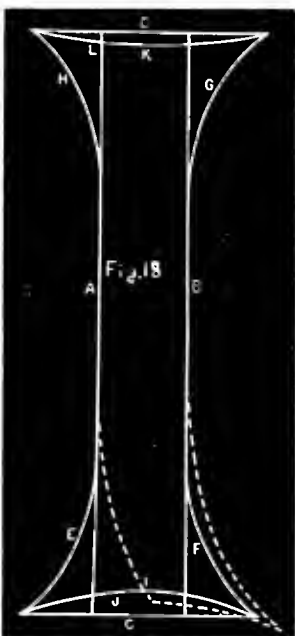

GIRDLE.

Fig. 18.

1. Draw line A and B 2 inches apart parallel with each other $\frac{3}{4}$ inch more than $\frac{1}{2}$ of waist measure, as shown in Fig. 18.

2. Draw lines C and D 6 inches in length across ends of lines A and B to a point 2 inches above line A.

3. Shape lines E, F, G and H with arm curve, according to taste.

4. Make dot I $\frac{1}{2}$ inch from line C.

5. Shape line J with dart curve from one end of line C to the other, across dot I.

6. Make dot K $\frac{1}{4}$ inch from center of line D.

7. Shape line L with dart curve from one end of line D to the other, across dot K.

Another style of pointed girdle can be drafted as illustrated by dotted lines in Fig. 18.

THE PRINCESS.

Fig. 19.

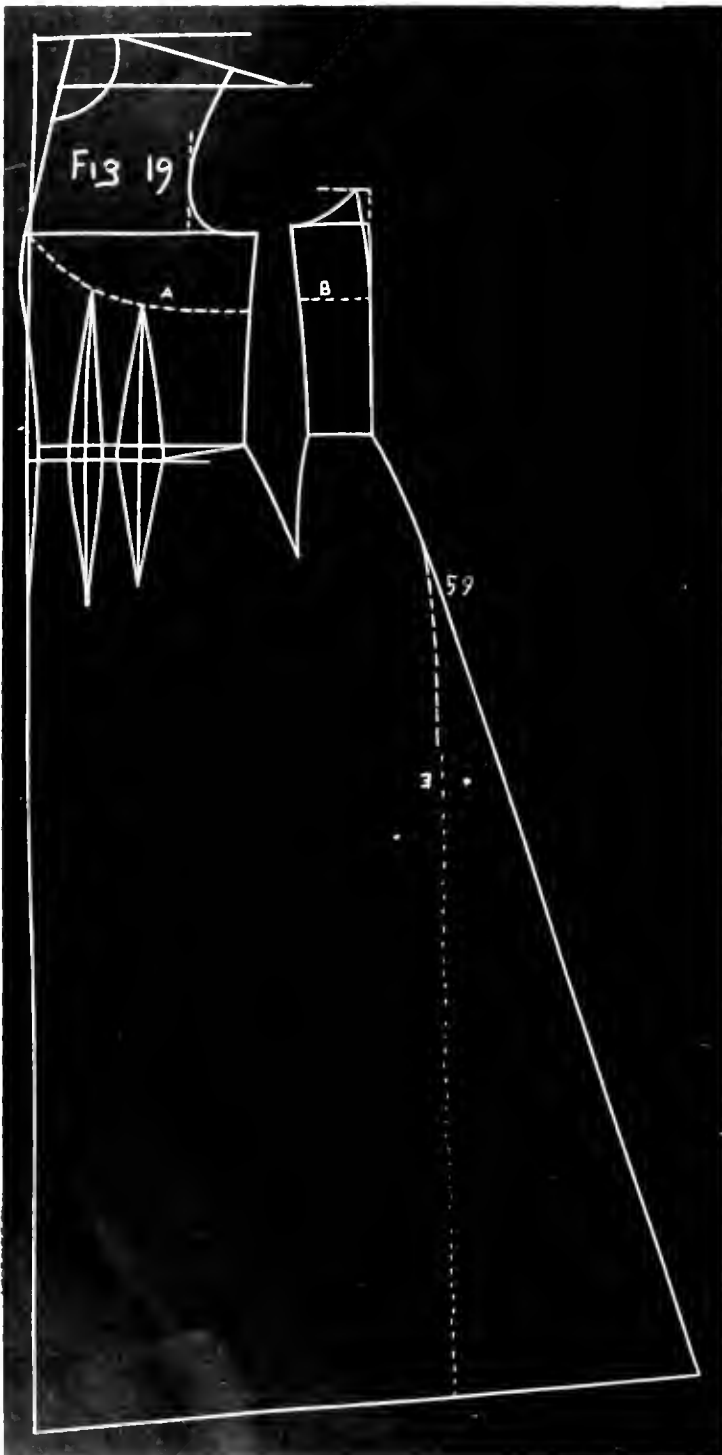

1. It is drafted the same as plain basque.
2. In tracing trace the front same as plain basque, continuing line 1 the length of skirt.
3. Trace darts to a point from 5 to 6 inches below the waist. When darts are very large and drawn from 5 to 6 inches below the waist it will cause a fullness in the front, to avoid this make the darts from $\frac{1}{2}$ to 1 inch smaller and take the same amount off of the waist line in front and under the arm as illustrated in Fig. 19.
4. Move under-arm piece over from 2 to $2\frac{1}{2}$ inches for under-arm dart and trace the under-arm piece continuing line 59 the length of skirt to a point from 27 to 30 inches from end of line 1 for all medium sizes. For extremely large figures more fullness can be given as desired.

The under-arm dart should be from 5 to 6 inches in length below the waist. Some cutters prefer to take a measure from the waist line under the arm to point of hip or the length they wish to make the dart. And then place the under-arm piece so that this dart will be the length of the measure taken below the waist.

If less fullness is wanted in bottom of skirt dotted line E can be used instead of line 59.

BACK OF PRINCESS.

Fig. 20.

1. Draft back same as plain basque.
2. Trace back same as plain basque.
3. Move side body over as shown in Fig. 20 about $1\frac{1}{2}$ inches so as to allow for seams.
4. Trace dart between back and side body to a point from 5 to 6 inches below the waist.
5. Continue line 35 the length of skirt, this line should be drawn straight from dot 29 parallel with line 1 the length of skirt.
6. Make dot A 2 inches below dot 8.
7. Draw line B from dot A square with line 1.
8. Make dot C on line B 12 inches from dot A, or according to fullness desired.
9. Draw line D from dot C square with line B to bottom of skirt.
10. Draw line E from end of line 35 to end of line D.

PRINCESS CORSAGE WITH BELL BACK.

Figs. 19 and 20.

Can be made as illustrated in Fig. 19 below dotted lines A and B in front of Princess, and in Fig. 20 below dotted lines C and D, in Bell Back Princess line 35 in the back draft joins dotted line E in front draft.

ADDRESS ALL COMMUNICATIONS TO HUGHES & STOREY, ST. LOUIS, MO.

PRINCESS WITH BELL BACK.

Fig. 20.

Is drafted same as Fig. 20, with the exceptions illustrated by dotted lines.

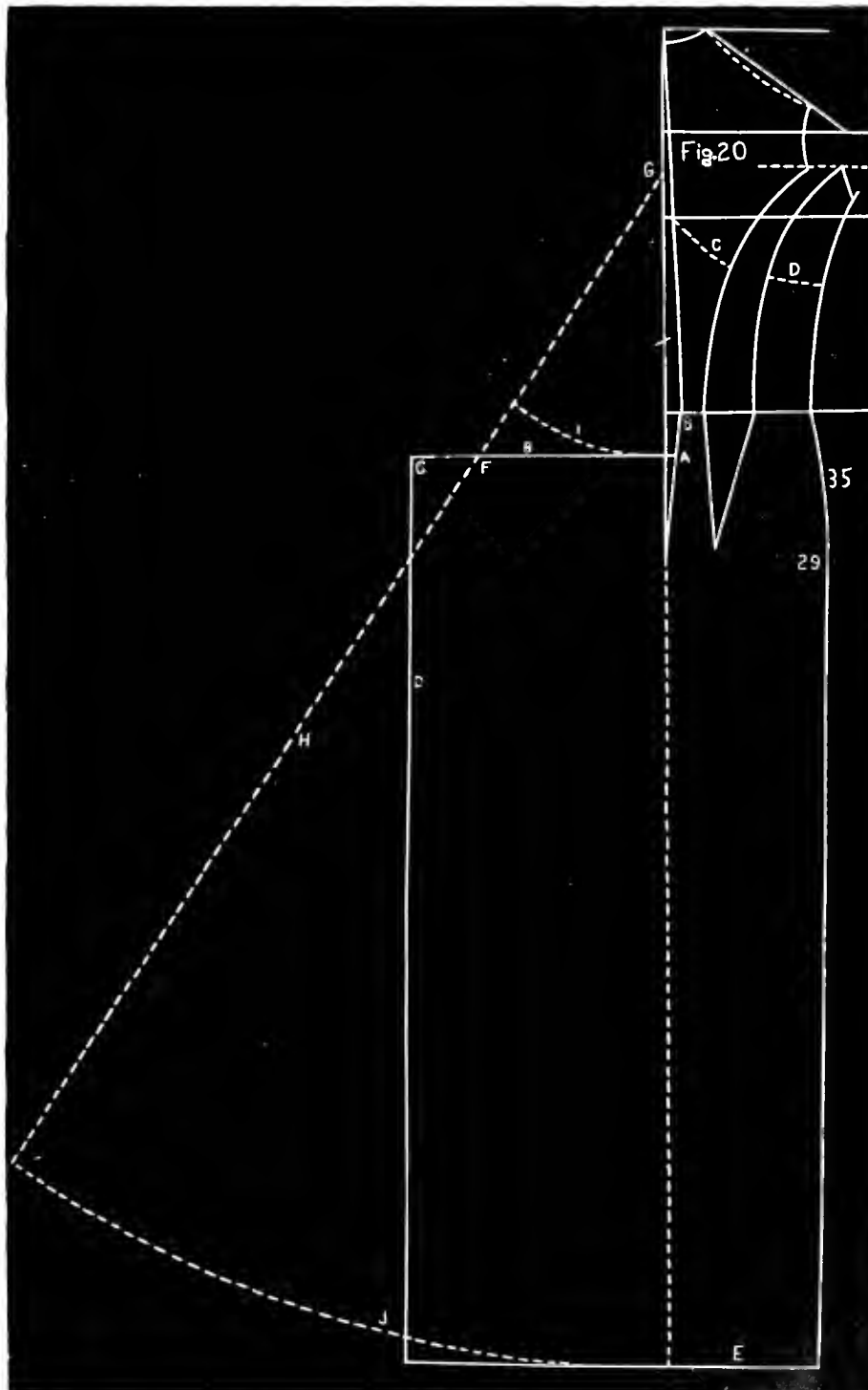

1. Continue line 1 to bottom of skirt.
2. Make dot F 9 inches from dot A on line B.
3. Make dot G 12 inches above dot A on line I.
4. Draw line H from dot G across dot F to bottom of skirt perfectly straight.
5. Sweep line I from dot A to line H, using dot G as a pivot.
6. Sweep line J from end of line I to line H, using dot G as a pivot.

ADDRESS ALL COMMUNICATIONS TO HUGHES & STOREY, ST. LOUIS, MO.

THE LADIES' TAILOR SYSTEM.

HOW TO TRACE OUT THE PRINCESS.

Fig. 21.

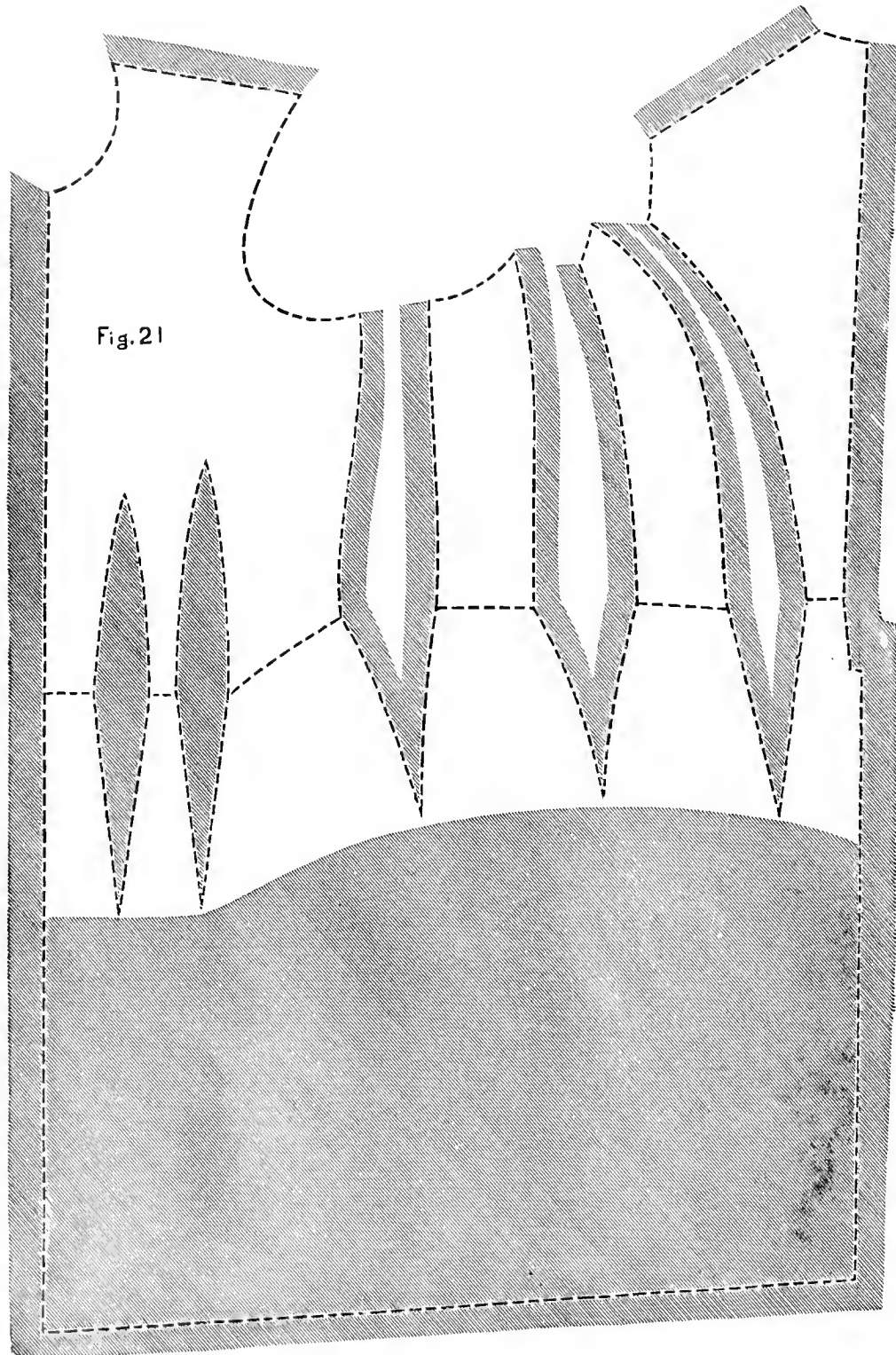

1. Make drafting according to style of Princess wanted.
2. Trace out the front under-arm piece, side body and back on paper, and cut out the different pieces so as to obtain a pattern, then place the pattern on the lining and trace it as illustrated in Fig. 21.

ADDRESS ALL COMMUNICATIONS TO HUGHES & STOREY, ST. LOUIS, MO.

THE LADIES' TAILOR SYSTEM.

SEAMLESS DRESS.

Consisting of Seamless Waist, Seamless Skirt and Seamless Sleeve.

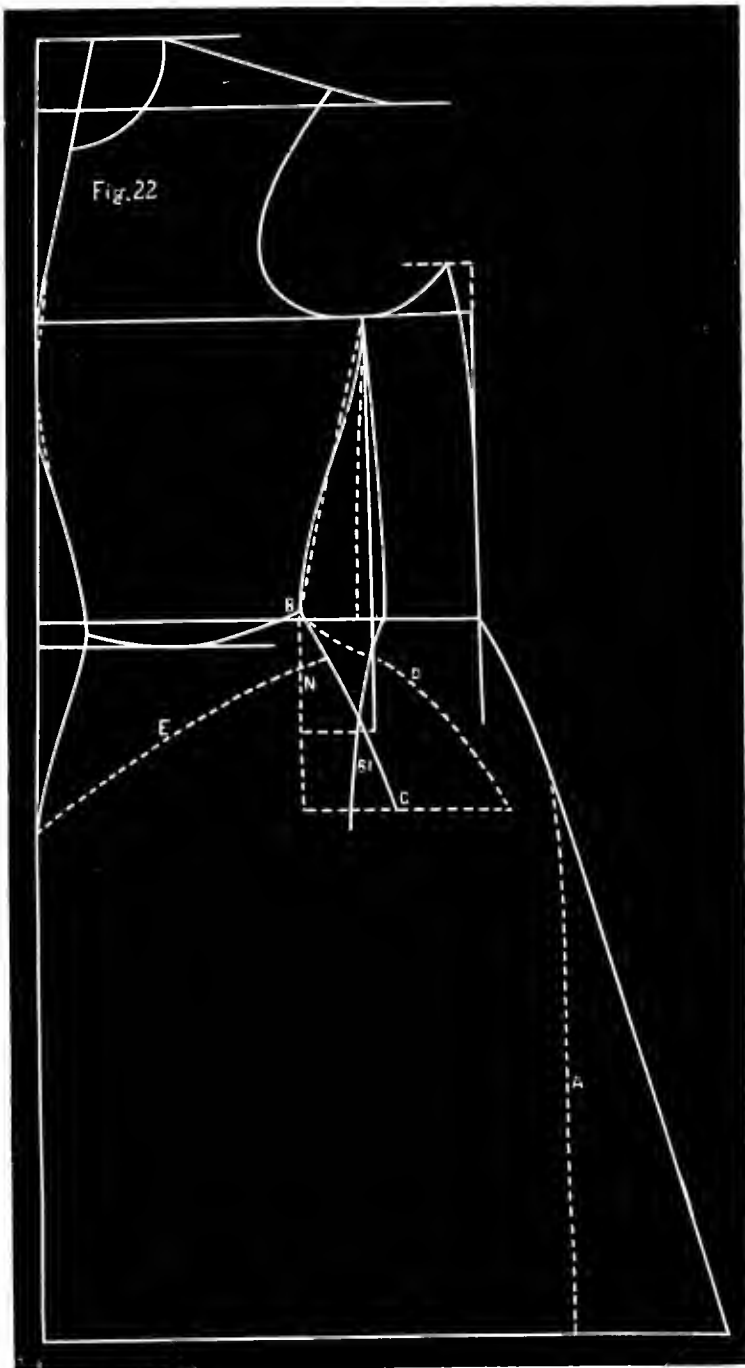

This garment is remarkable because of the novelty of being seamless, and can be made up so as to appear very beautiful.

The waist is drafted same as Fig. 24. The skirt is drafted same as Fig. 13, and then, instead of making one seam, button or lace the skirt down the side.

The sleeve is made the same as One-Seam Sleeve in Fig. 7, and laced down the inside.

DARTLESS PRINCESS.

Fig. 22.

Is cut so as to remove the difficulty of having darts in the front, as shown in Fig. 22.

1. Make drafting same as for the Parisian Dartless Basque.

2. Trace out front, under-arm piece, side form and back on paper, and cut out the different pieces so as to obtain a pattern, then place the pattern on the lining and trace it as illustrated in Fig. 21. If the goods is narrow, put a seam in the skirt between the under-arm piece and side body, as illustrated by dotted line A.

DARTLESS DRAPED PRINCESS.

Fig. 22.

1. Extend line N to a point $5\frac{1}{2}$ inches below dot B, as shown in Fig. 22.
2. Draw line C from the end, and square with line N, $5\frac{1}{2}$ inches long.
3. Draw line D from dot B to end of line C (with dart curve).

The space on line D from dot B to end of line C is plaited on line F for draping, line D, is usually drawn straight down from end of line C to the bottom of skirt. When draping is wanted on one side only, the front can be cut basque shape on the same side of the draping as illustrated by dotted line E, and the skirt draped up over the lower part of basque.

ADDRESS ALL COMMUNICATIONS TO HUGHES & STOREY, ST. LOUIS, MO.

THE LADIES' TAILOR SYSTEM.

SEAMLESS PRINCESS.

Fig. 23.

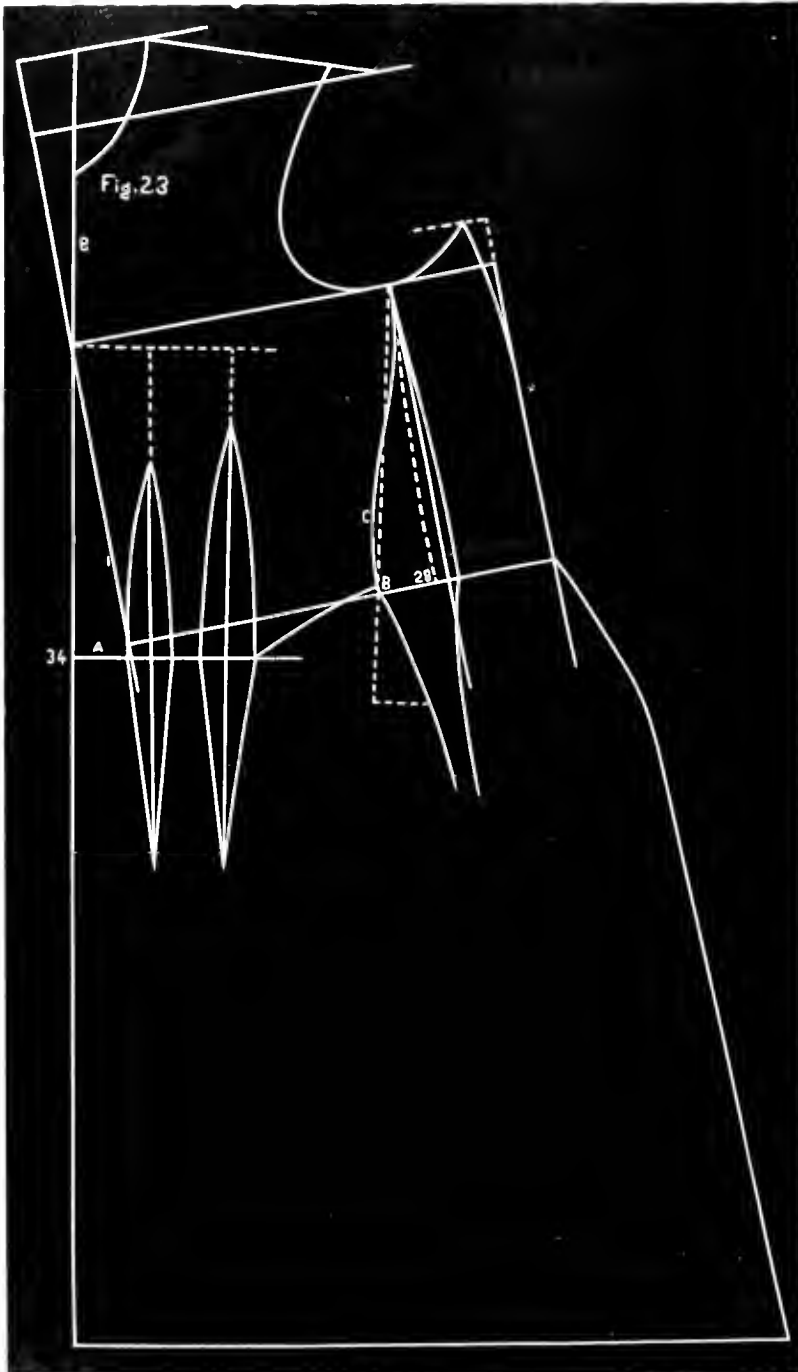

Is so called because the fronts under-arm piece, side-body and back are all cut in one piece as illustrated in Fig. 21 and it opens under the arm and on the shoulder, or in the center of back.

1. The back draft is made same as plain Princess. For slender forms the French Back, same as Fig. 5 can be used.

2. The front draft is made the same as French bias basque to the waist line.

3. The front darts are made on line A and the same size as for plain basque.

4. Make dot B the same distance from dot 28 that line 1 is from dot 34.

5. Draw line C same as line F in the dartless basque.

6. In tracing out the front, fold the lining double and place line 9 on edge of fold and trace out the front.

7. Trace out under-arm, side-form and back pieces same as for plain Princess.

In cutting this garment place the pattern on the lining and trace it as illustrated in Fig. 21 making the darts come to a point about 6 inches below the waist line.

THE LADIES' TAILOR SEAMLESS WAIST.

Fig. 24.

1. Draft the front part of the waist the same as instruction draft leaving out the darts and under-arm line.

2. Below the draft draw a straight line as in Fig. 24.

3. Make dot A at the beginning of the line, and dot B at width of back measure from dot A in half inch figures.

4. Make dot C at waist measure in waist figures from dot A.

5. Make dot D $1\frac{1}{4}$ inches from dot C.

6. Measure the distance from dot A to dot D and place the amount of this measure on System at dot 5 and make dot 32 at waist measure in half inch figures on line 27.

7. Measure the space between dots 32 and 19 and make dot E $\frac{1}{4}$ inch more than $\frac{1}{2}$ of this space from dot 19 and make dot F $\frac{1}{4}$ inch less than $\frac{1}{2}$ of this space from dot 34.

8. Draw line G straight from dot 23 across dot E.

9. Measure the space between dots D and B and place this amount on short arm of System on line G, at the same time place the under-arm measure on long arm of System at the junctions of line 15 and G as illustrated then draw lines H and I.

10. Make dot J on line I the width of back measure from line H in half inch figures.

11. Draw line K square with line H from junctions of line 15 and G.

12. Make dot L the width of back measures on line K in half inch figures from the junction of lines H and 15.

13. Place length of back measure of long arm of System at dot J and draw line M across dot L the length of back measure.

14. Make dots 2, 3, 14, 17, 19, and lines 13, 15, 16, 18 and 24 same as in instruction draft. This part is drafted same as plain basque, except the lines are drawn toward you instead of from you and line 24 is drawn with System turned face down, then draw line 24.

THE LADIES' TAILOR SYSTEM.

15. Make dot N the height of dart measure above dot 34.
16. Place point S on System at dot F and draw line O to dot N.
17. Curve the front slightly at dots 3 and N with dart curve.

18. Extend line M $\frac{1}{4}$ inch below dot J in center of back at the waist line.
19. Shape waist line (line P) with dart curve as illustrated by dotted lines.
20. This waist can be made pointed in back and front as shown by dotted lines.

The proper make-up of this garment is very important, because the entire front, both of lining and outside material is cut on the bias, and stretches easily. The goods in front, from a point about 1 inch below dot N to a point about 2 inches above dot 3, should be held full, and from a point below dot N to waist line, should be stretched from $\frac{1}{4}$ to $\frac{1}{2}$ inch, and then stayed with a tape from the waist line to neck, to prevent drawing out of shape. Whalebone casing should be stitched onto the lining before it is basted to the goods. This waist is usually made to lace down the front.

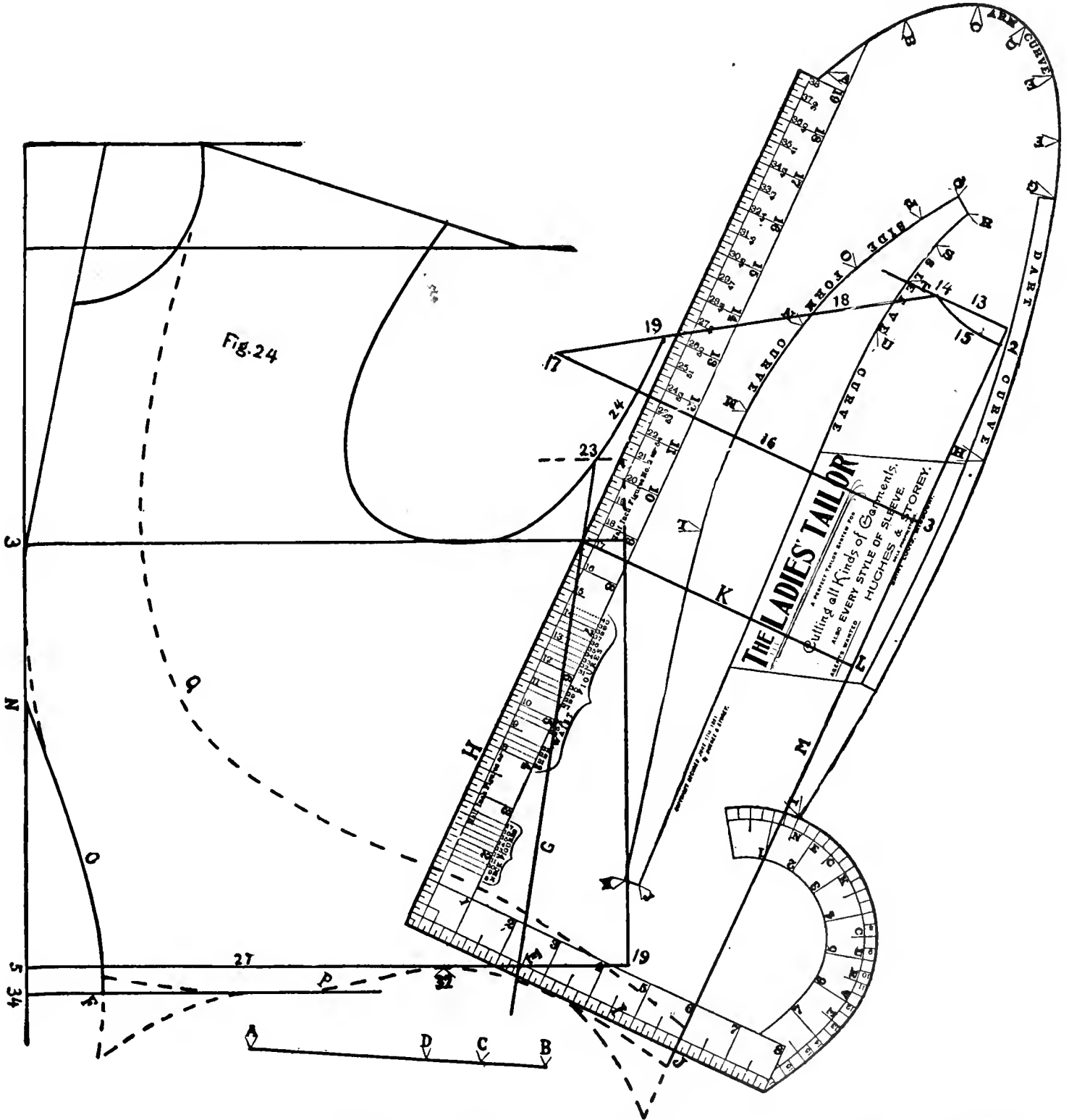

ADDRESS ALL COMMUNICATIONS TO HUGHES & STOREY, ST. LOUIS, MO.

THE RIDING HABIT.

Fig. 25.

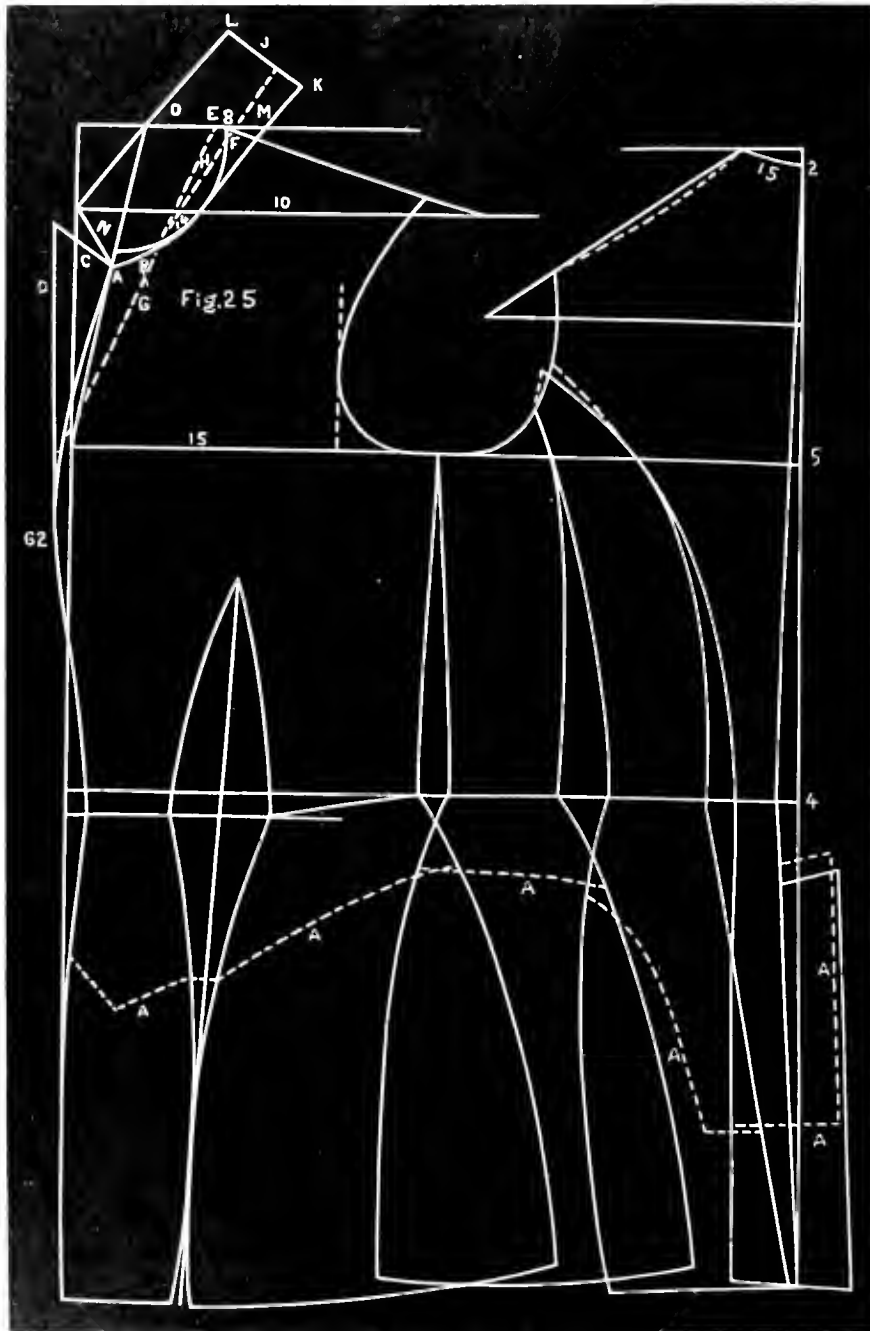

The measure for outside garments are taken the same as for ladies' basque and then one inch is added to the neck, bust, waist, hip, arms-eye, elbow and hand measures.

1. Draft the front same as in instruction draft.
2. Extend line 15 and make dot 5 the bust measure in half inch figures.
3. Draw line 1 of back draft square with line 15 from dot 5 and make dot 4 the under-arm measure below line 15.
4. Make dot 2 the length of back measure above dot 4.
5. Make the remainder of back part of drafting the same as in instruction draft and as illustrated in Fig. 25. To do this all the curved lines are drawn with the system turned face downward.

6. Shape the bottom of habit as illustrated by dotted lines A, A, A, A, A, A. When one dart is used much trouble is often caused by not putting it in the correct place. It should be made in the center between the points where the darts would ordinarily come for all medium or slender forms. When bust measure is large it should be set one half inch back of the center, place the dart in this position and you will remove the cloth at the right place.

THE LAPEL AND COLLAR.

Fig. 25.

Lapel and collar is drafted as shown in Fig. 25.

1. Make dot A $\frac{1}{2}$ inch from neck curve on line 9.
2. Draw line B from dot A to neck curve.

3. Draw line C from dot A 2 inches long or length and slope desired.
4. Draw line D from the end of line C to dot 62.
5. Make dot E $\frac{1}{4}$ inch from dot 8.
6. Make dot F $\frac{1}{4}$ inch from dot 8 on shoulder line.
7. Draw line G from dot E to any point on front that gives the desired length of lapel.
8. Draw line H from junction of lines G and neck curve across dot F to a point $\frac{1}{2}$ inch more than the length of line 15 in back.

9. Draw line J square with line H.
10. Make dot K $\frac{3}{4}$ inch from end of line H.
11. Make dot L $1\frac{3}{4}$ inches from end of line H (or the width of collar).
12. Draw line M with dart curve from dot K to junction of lines 10 and 14.
13. Draw line N $1\frac{1}{2}$ inches from dot A, any slope desired.
14. Draw line O from dot L to end of line N (straight or slightly curved).

THE LADIES' TAILOR SYSTEM.

BACK OF RIDING HABIT SKIRT.

Fig. 26.

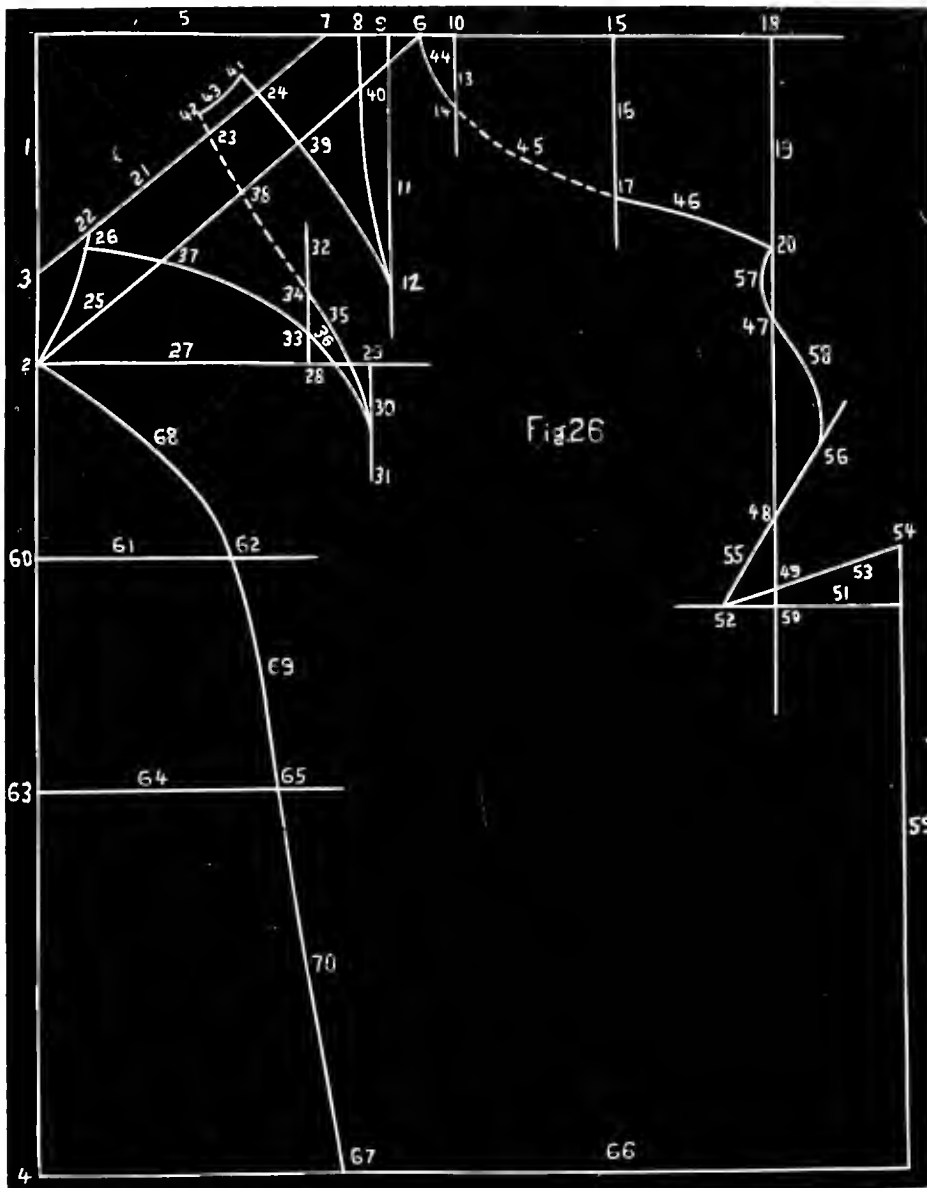

1. Straight line.
2. $15\frac{1}{2}$ inches always.
3. $4\frac{1}{2}$ inches always.
4. Front skirt measure from dot 2.
5. Straight line.
6. The waist measure from dot 2.
7. $4\frac{1}{4}$ inches from dot 6.
8. $\frac{1}{8}$ of waist from dot 6.
9. $\frac{1}{2}$ way between dots 6 and 8.
10. $1\frac{1}{2}$ inches from dot 6.
11. Straight line.
12. 10 inches always.
13. Straight line.
14. $3\frac{1}{2}$ inches always.
15. $7\frac{1}{2}$ inches from dot 10 always.
16. Straight line.
17. $7\frac{1}{2}$ inches always.
18. $7\frac{1}{2}$ inches.
19. Straight line.
20. 10 inches.
21. Straight line.
22. $\frac{1}{8}$ of waist measure from dot 3.
23. One-half way between dots 22 and 7.
24. $\frac{1}{8}$ of waist measure from dot 23.
25. Point E at dot 22.
26. $\frac{1}{4}$ of waist from dot 2.
27. Straight line.
28. $12\frac{1}{2}$ inches from dot 2 always.
29. 3 inches from dot 28.
30. Straight line.
31. 3 inches from dot 29.
32. Straight line.
33. $1\frac{1}{2}$ inches from dot 28.
34. $3\frac{1}{2}$ inches from dot 28.
35. Point E at dot 31.
36. Point E at dot 31.

37. Point E at dot 33.
38. Point G at dot 34.
39. Point T at dot 12.
40. Point F at dot 12.
41. Is the same distance from dot 12 that dot 8 is.
42. Is the same distance from dot 31 that dot 26 is.
43. Curved line.
44. Point E at dot 14.
45. Point O at dot 14.
46. Point F at dot 17.
47. $3\frac{1}{2}$ inches from dot 20.
48. $9\frac{1}{4}$ inches from dot 47.
49. $3\frac{1}{4}$ inches from dot 48.
50. 4 inches from dot 48.
51. Straight line.
52. $2\frac{1}{2}$ inches from dot 50.
53. Straight line.
54. 9 inches from dot 52.
55. Straight line.

56. 9 inches from dot 52.
57. Neck curve.
58. Point D at dot 56.
59. Straight line.
60. 9 inches from dot 2.
61. Straight line.
62. 9 inches from dot 60.
63. 11 inches from dot 60.
64. Straight line.
65. 11 inches from dot 63.
66. Straight line.
67. 14 inches from dot 4.
68. Point E at dot 62.
69. Point T at dot 62.
70. Straight line.

Dots 54 and 56 sews together in a dart.
 Dots 26 and 42 sews together in a dart.
 Dots 8 and 41 sews together in a dart.

ADDRESS ALL COMMUNICATIONS TO HUGHES & STOREY, ST. LOUIS, MO.

THE LADIES' TAILOR SYSTEM.

FRONT OF RIDING HABIT SKIRT.

Fig. 27.

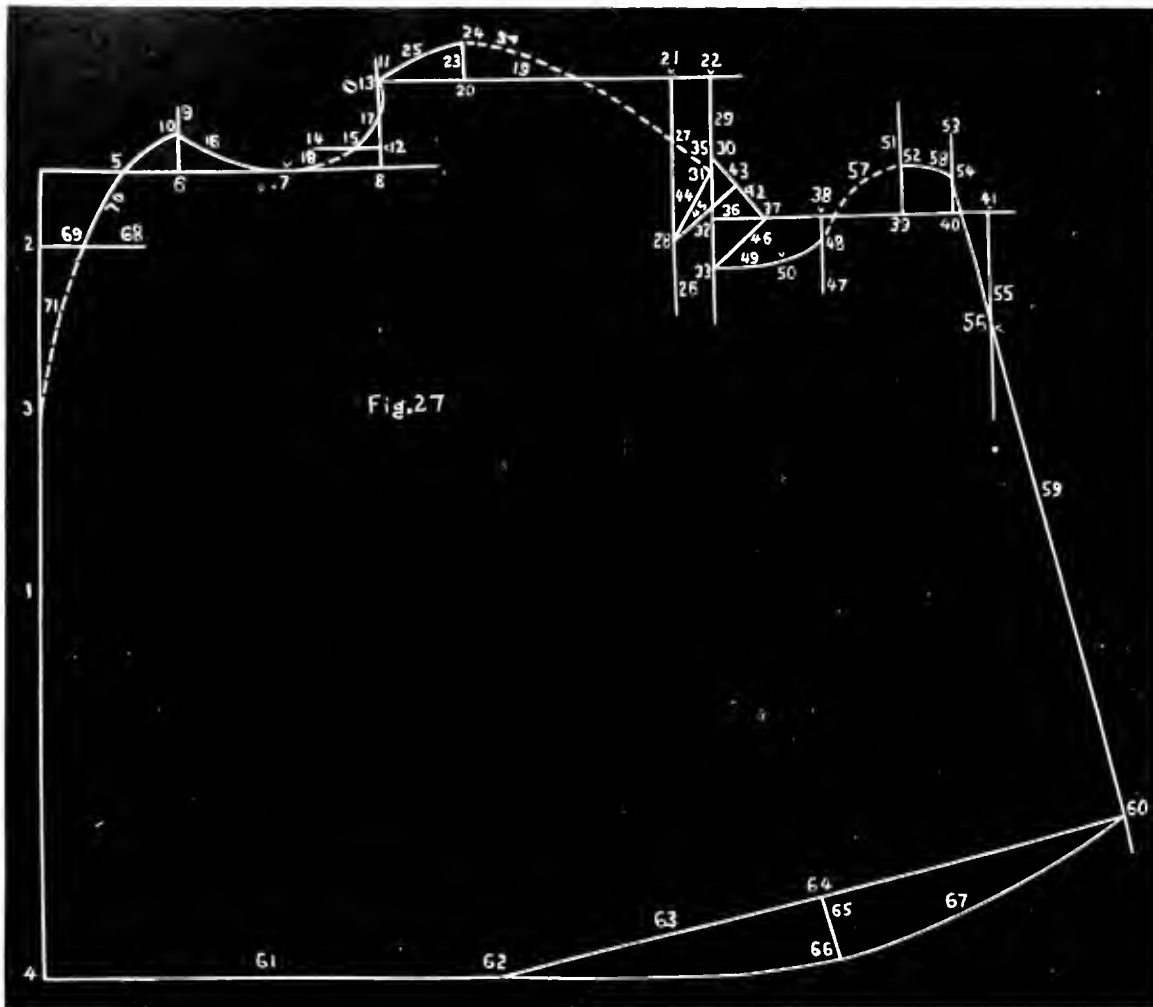

1. Straight line.
2. $3\frac{3}{4}$ inches from top of line 1.
3. $11\frac{1}{2}$ inches from top of line 1.
4. Front skirt measure.
5. Straight line.
6. $\frac{1}{4}$ of waist from line 1 always.
7. $\frac{1}{4}$ of waist from dot 6 always.
8. $\frac{1}{6}$ of waist from dot 7 always.
9. Straight line.
10. 2 inches from dot 6.
11. Straight line.
12. 1 inch from dot 8.
13. $\frac{1}{4}$ waist from dot 8.
14. Straight line.
15. 1 inch from dot 12.
16. Point Q at dot 7.
17. Neck curve.
18. Point E at dot 15.
19. Straight line.
20. 4 inches from dot 13.

21. 14 inches from dot 13.
22. $15\frac{3}{4}$ inches from dot 13.
23. Straight line.
24. $1\frac{1}{2}$ inches from dot 20.
25. Point E at dot 13.
26. Straight line.
27. 3 inches from dot 21.
28. $7\frac{1}{2}$ inches from dot 21.
29. Straight line.
30. $3\frac{3}{4}$ inches from dot 22.
31. $4\frac{1}{4}$ inches from dot 22.
32. $6\frac{3}{4}$ inches from dot 22.
33. 9 inches from dot 22.
34. Point E at dot 24.
35. Point F at dot 31.
36. Straight line.
37. $2\frac{1}{4}$ inches from dot 32.
38. $4\frac{1}{2}$ inches from dot 32.
39. 9 inches from dot 32.
40. $11\frac{1}{2}$ inches from dot 32.
41. 13 inches from dot 32.
42. Straight line from dot 37 to dot 30.

43. 2 inches from dot 37.
44. Straight line from dot 28 to dot 31.
45. Straight line from dot 28 to dot 43.
46. Straight line from dot 33 to dot 37.
47. Straight line.
48. 1 inch from dot 38.
49. Point D at dot 48.
50. $3\frac{1}{4}$ inches from dot 33.
51. Straight line.
52. $2\frac{1}{4}$ inches from dot 39.
53. Straight line.
54. $1\frac{1}{2}$ inches from dot 40.
55. Straight line.
56. 6 inches from dot 41.
57. Point D at dot 52.
58. Point E at dot 52.
59. Straight line from dot 54 across dot 56.
60. $31\frac{1}{4}$ inches from dot 13 following curved lines and leaving out the

darts, making it the same length of line in back from dot 6 to dot 56, following curved lines, then from dot 54 down line 59 to line 66, these two lines sew together.

61. Straight line.
62. 22 inches from dot 4.
63. Straight line from dot 62 to dot 60.
64. Make a dot in centre of line 63.
65. Straight line.
66. 3 inches from dot 64.
67. Curve line from dot 60 across dot 66 to dot 62.
68. Straight line.
69. $1\frac{1}{2}$ inches from dot 2.
70. Point E at dot 10.
71. Point F at dot 69.

Dots 37 and 50 sews together in a dart.

Dots 43 and 31 sews together in a dart.

ADDRESS ALL COMMUNICATIONS TO HUGHES & STOREY, ST. LOUIS, MO.

THE LADIES' TAILOR SYSTEM.

FRONT OF RIDING HABIT TROUSERS.

Fig. 28.

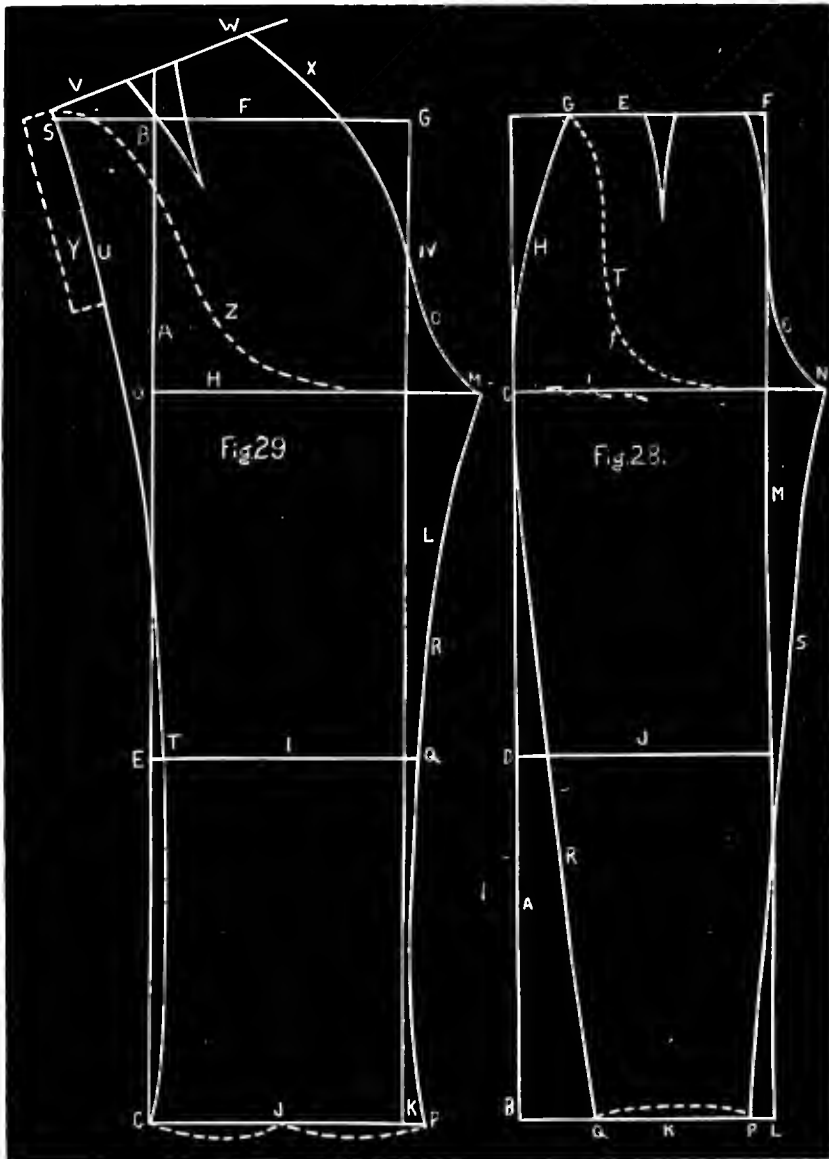

(Measures for trousers. Waist 24, hip 40, outside length 40). Is drafted as follows :

1. Draw line A straight.
2. Make dot B outside length from top of line A.
3. Make dot C 1 inch more than $\frac{1}{4}$ of hip measure from top of line A.
4. Make dot D half way between dots C and B.
5. Draw line E square with line A.
6. Make dot F $\frac{1}{4}$ of hip measure from top of line A.
7. Make dot G $1\frac{1}{2}$ inches more than $\frac{1}{4}$ of waist measure from dot F.
8. Draw line H from dot G to dot C with arm curve.
9. Make a dart 1 inch in size 4 inches long half way between dots F and G also $\frac{1}{2}$ inch dart inside of dot F.
10. Draw lines I, J and K square with line A.
11. Make dot L $\frac{1}{4}$ of hip measure from dot B.
12. Draw line M straight from dot F to dot L.
13. Make dot N $2\frac{1}{2}$ inches outside of line M.
14. Draw line O with arm curve.
15. Make dot P 1 inch inside of dot L.
16. Make dot Q 6 inches from dot P.
17. Draw line R from dot C to dot Q slightly curved at top.
18. Draw line S from dot N to dot P slightly curved at top.

BACK OF RIDING HABIT TROUSERS.

Fig. 29.

1. Draw line A.
 2. Make dot B 2 inches from top of line A.
 3. Make dot C the outside length from dot B.
 4. Make dot D $\frac{1}{4}$ of hip measure from dot B.
 5. Make dot E half way between dots C and D.
 6. Draw line F square from line A.
 7. Make dot G $\frac{1}{4}$ of hip measure from dot B.
 8. Draw lines H, I and J square from line A.
 9. Make dot K $\frac{1}{4}$ of hip measure from dot C.
 10. Draw line L straight from dot G to K.
 11. Make dot M 3 inches outside of line L.
 12. Make dot N half way between dot G and line H.
 13. Draw line O from dot M to dot N with arm curve.
 14. Make dot P 1 inch outside of dot K.
 15. Make dot Q $\frac{1}{2}$ inch outside of line L.
 16. Draw line R from dot M across dot Q to dot P slightly curved.
 17. Make dot S 4 inches from dot B.
 18. Make dot T $\frac{1}{2}$ inch inside of dot E.
 19. Draw line U from dot C across dot T to a point 1 inch above dot S, slightly curved.
 20. Draw line V from end of line U across end of line A.
 21. Make dot W 2 inches more than $\frac{1}{4}$ of waist measure.
 22. Draw line X from dot W to dot N, slightly curved.
- Make a dart half way between dot W and end of line U 2 inches in size and 5 inches long.
- Dotted line Y represents flap and opening on the side 8 inches long. Some prefer the space above dotted line Z in Fig. 29 and dotted line T in Fig. 28 made of lining only, while others prefer both lining and outside material.

ADDRESS ALL COMMUNICATIONS TO HUGHES & STOREY, ST. LOUIS, MO.

THE LADIES' TAILOR SYSTEM.

LADIES' WALKING JACKET.

Fig. 25.

Continue skirt lines of habit, as shown in figure 25, from 9 to 12 inches, or length desired for jacket.

THE LADIES' DOUBLE BREASTED PRINCE ALBERT COAT.

Fig. 30.

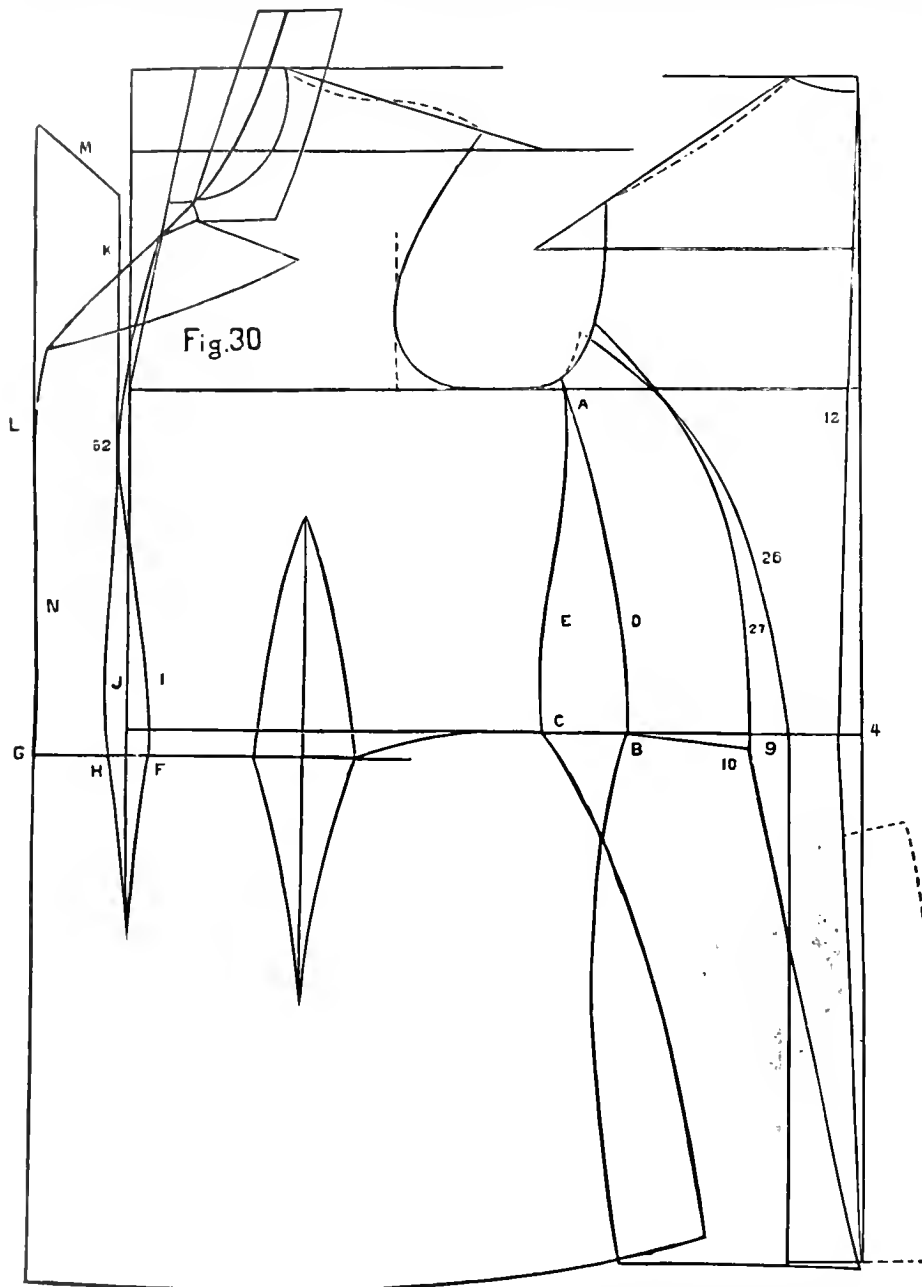

The drafting for this coat is made the same as figure 25, with the following exceptions shown in figure 30 :

1. Make dot A $1\frac{1}{4}$ inches more than width of back measure in $\frac{1}{2}$ inch figures from line 12.
2. Make dot B $1\frac{1}{4}$ inches more than waist measure in waist figures from dot 4.
3. Make dot C 2 inches from dot B.
4. Lines 26 and 27 can be drawn with side form curve or shaped according to taste of the cutter, and the space between dots 9 and 10 should be 1 inch.
5. Draw lines D and E with dart curve, shaping them as illustrated in figure 30.
6. Make dot F on waist line $\frac{1}{2}$ inch inside of line 1.
7. Extend waist line and make dot G $2\frac{1}{4}$ inches from line I.
8. Make dot H $\frac{1}{2}$ inch outside of line I.
9. Draw line I from dot F the same as line 63 in front drafting.
10. Draw line J from dot H the same as line I (turn system over).
11. Draw line K $\frac{1}{4}$ inch outside and parallel with line 1 from the neck to dot 62.
12. Make dot L 2 inches outside of dot 62.
13. Draw line M any slope desired.
14. Draw line N from line M across dots L and G straight down to length of skirt.
15. Make a dart between dots F and H to a point 4 inches below the waist.

NEW MARKET.

Fig. 31.

Draft same as figure 25, with the following exceptions :

1. Make French back same as figure 5.
2. Make front dart 2 inches in size $2\frac{1}{2}$ inches from measure.
3. Make under-arm dart 1 inch in size.
4. Make skirt lines the full length of dress skirt line 1.
5. Lapel and collar can be made same as figure 25, or can be cut with shawl collar as shown in figure 3.

ULSTER.

Fig. 31.

It is made the same as the Newmarket in figure 31, with the following exception :

The front dart is omitted in figure 31.

ADDRESS ALL COMMUNICATIONS TO HUGHES & STOREY, ST. LOUIS, MO.

LADIES' BOX COAT.

Fig. 31.

The rules for producing this coat are the same as for a Newmarket, with the following exceptions shown in Fig. 31:

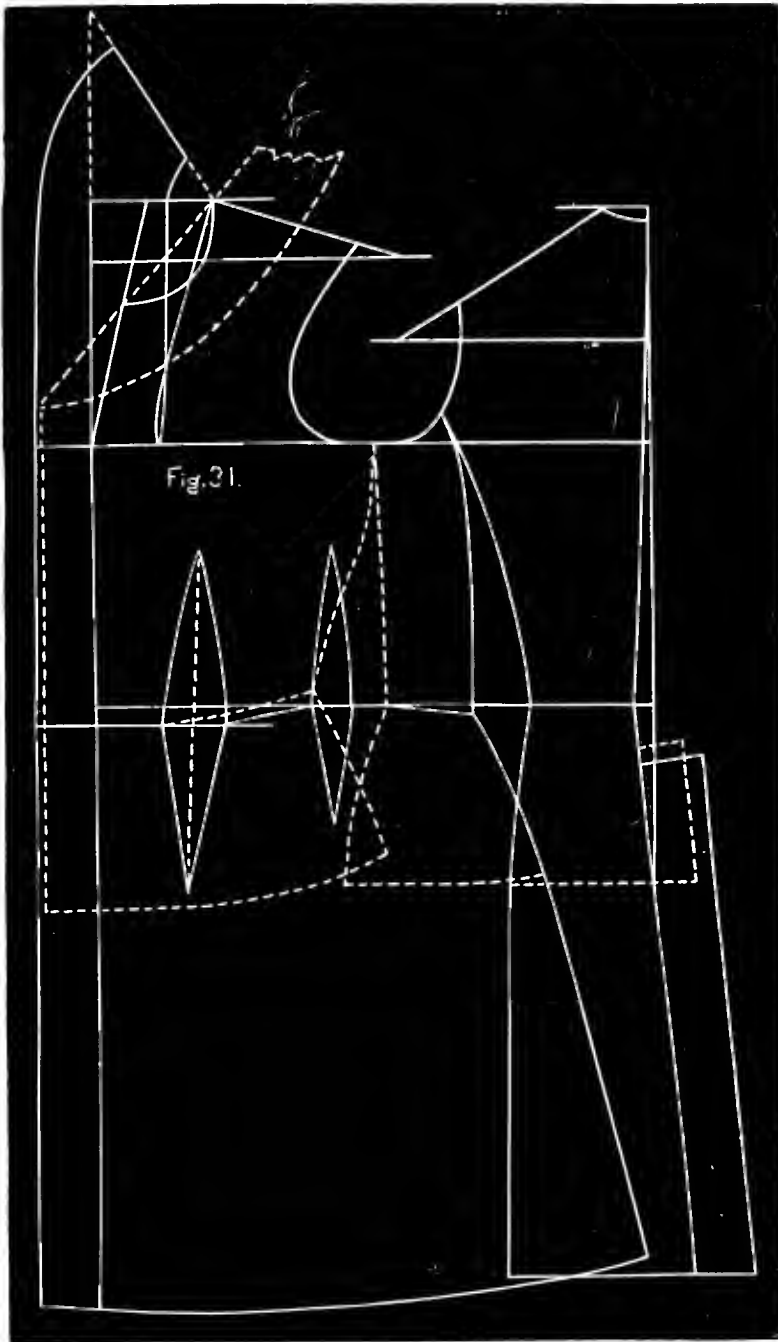

1. The under-arm piece is made same as in plain drafting.
2. The front is cut full double breasted without darts, except that $1\frac{1}{2}$ inches is taken off of the front under the arm the same as in dartless basque.
3. The skirt is only made about 6 inches long.

LADIES' DOLMAN.

Fig. 32.

In this garment the bust measure is not taken as given in the instruction book; but is taken over the fullest part of the bust outside the arms. It should be taken as you wish the garment to fit. This measure is taken loosely.

The front and back are drafted the same as for the Parisian Dartless coat as in Fig. 3 and 4 with the following exceptions:

1. Make dot A 3 inches from dot 16.
2. Draw dotted line B square with line 15 from dot A to waist line.
3. Make dot C $1\frac{1}{2}$ inches from line B on line 27.
4. Make dot D $1\frac{1}{2}$ inches from line 1 on line 35.
5. Make dot E the bust measure from dot 3 in half inch figures.
6. Make dot F the width of back measure in half inch figures from line 12.
7. Make dot G $1\frac{1}{2}$ inches from line 12 on line 27.
8. Place point F on System at dot 19 and draw line H to dot G.
9. Draw dotted line I across dot 16 parallel with line 1.
10. Make dot J on line I 3 inches above dot 16.
11. Draw dotted line K $2\frac{1}{2}$ inches long square from dot F.
12. Draw line L from dot J to end of line K.
13. Make dot M in centre of line L.

14. Draw line N square with line L the same length above dot M that dot J is from dot M, shaping line Y as illustrated in Fig. 32 or sweep with tape using dot M as a pivot.

15. Make dot O on line I half the under-arm measure below dot 16.

16. Draw line P from dot 16 to dot O use dart curve.

17. Place point D on System at dot O and draw dotted line Q to a point $\frac{1}{4}$ inch outside of line 1 and 2 inches above waist line.

18. Draw line R the same as line Q to a point 3 inches above waist line.

19. Draw line S 5 inches long parallel with line 1 from end of line Q.

20. Draw line T from end of line R to end of line S.

21. Draw dotted line U from end of line S to a point 3 inches below waist line on dotted line I (using dart curve).

22. Draw line V from dot O to end of line U (use dart curve).

THE LADIES' TAILOR SYSTEM.

23. Make dot W 12 inches below dot C on skirt line.
24. Draw line X from end of line S to dot W shaping it according to taste, shape bottom of skirt lines with dart curve.
25. Draw line Z from dot 25 to a point 2 inches below dot A.

Dotted lines S, Q, U and V represent the under part of sleeve. Lines 13, 27, Y, P, R, T, X and bottom lines of skirt represents the upper part of sleeve. Double dotted lines show where elastic is secured to back and front under the arm and at waist line.

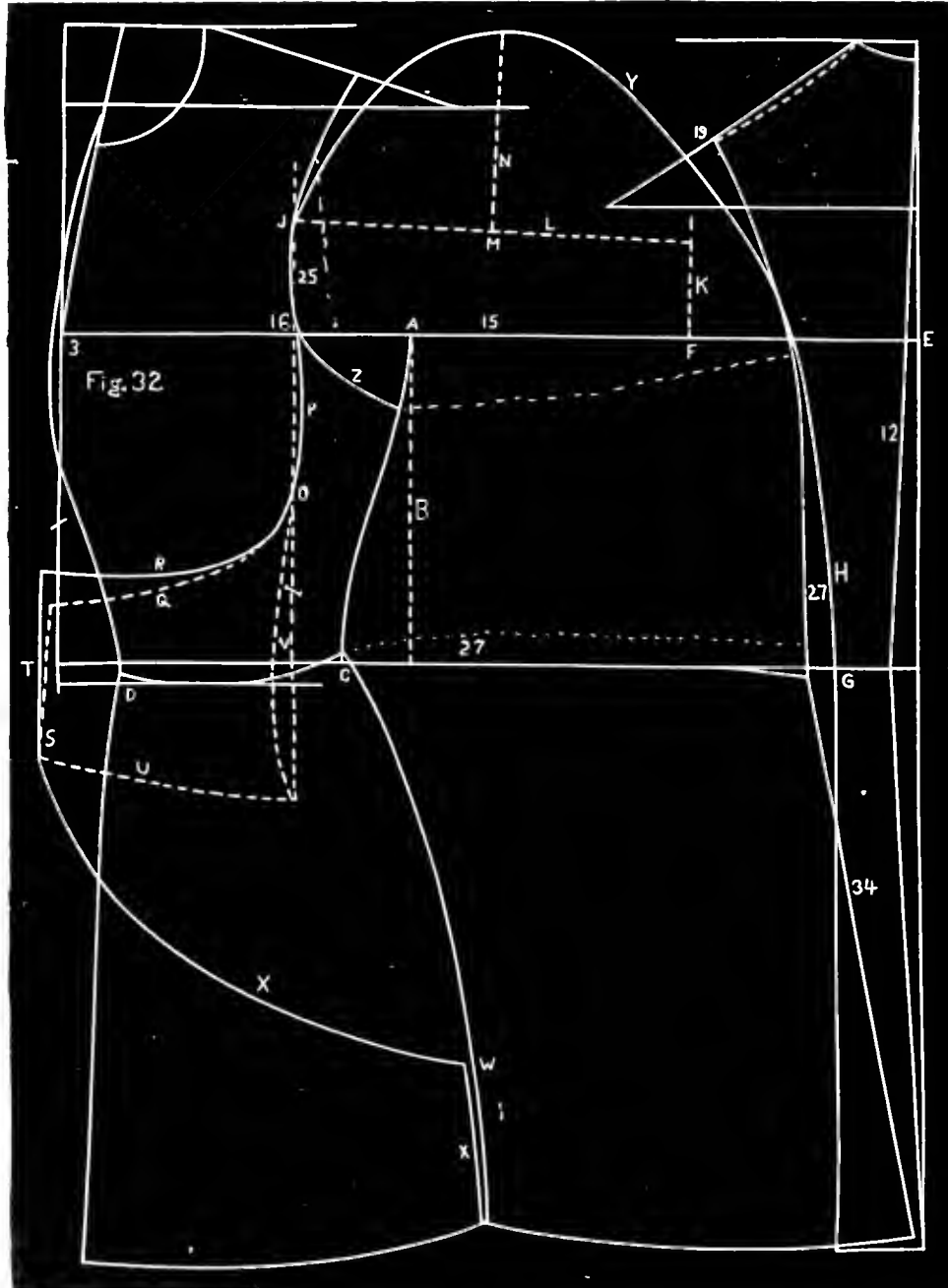

HIGH SHOULDER CAPE.

Fig. 33.

In this garment the bust measure is not taken as given in instruction book, but it is taken over the fullest part of the bust, outside the arms. It should be taken as closely as you wish the garment to fit. Shoulder measures for this cape should be $\frac{1}{2}$ inch shorter than for ordinary basque. Front and back as illustrated in Fig. 33 are drawn the same as instruction draft with the following exceptions :

ADDRESS ALL COMMUNICATIONS TO HUGHES & STOREY, ST. LOUIS, MO.

THE LADIES' TAILOR SYSTEM.

1. Extend line 15 and make dot A the bust measure from dot 3 in half inch figures.

2. Make dot B $2\frac{1}{2}$ inches above dot 21.

3. Make dot C 3 inches above dot 16.

4. Draw line D from dot C to dot B.

5. Make dot E in center of line D.

6. Draw line F square from dot E and make dot G the same distance from dot E that dot C is from dot E.

7. Shape line H from dot C to dot G and from dot B to dot G as shown in Fig. 33.

8. Spaces between lines 26 and H and 24 and H comes out as a dart. This cape is usually made to a point 1 inch below waist line but can be made any length desired.

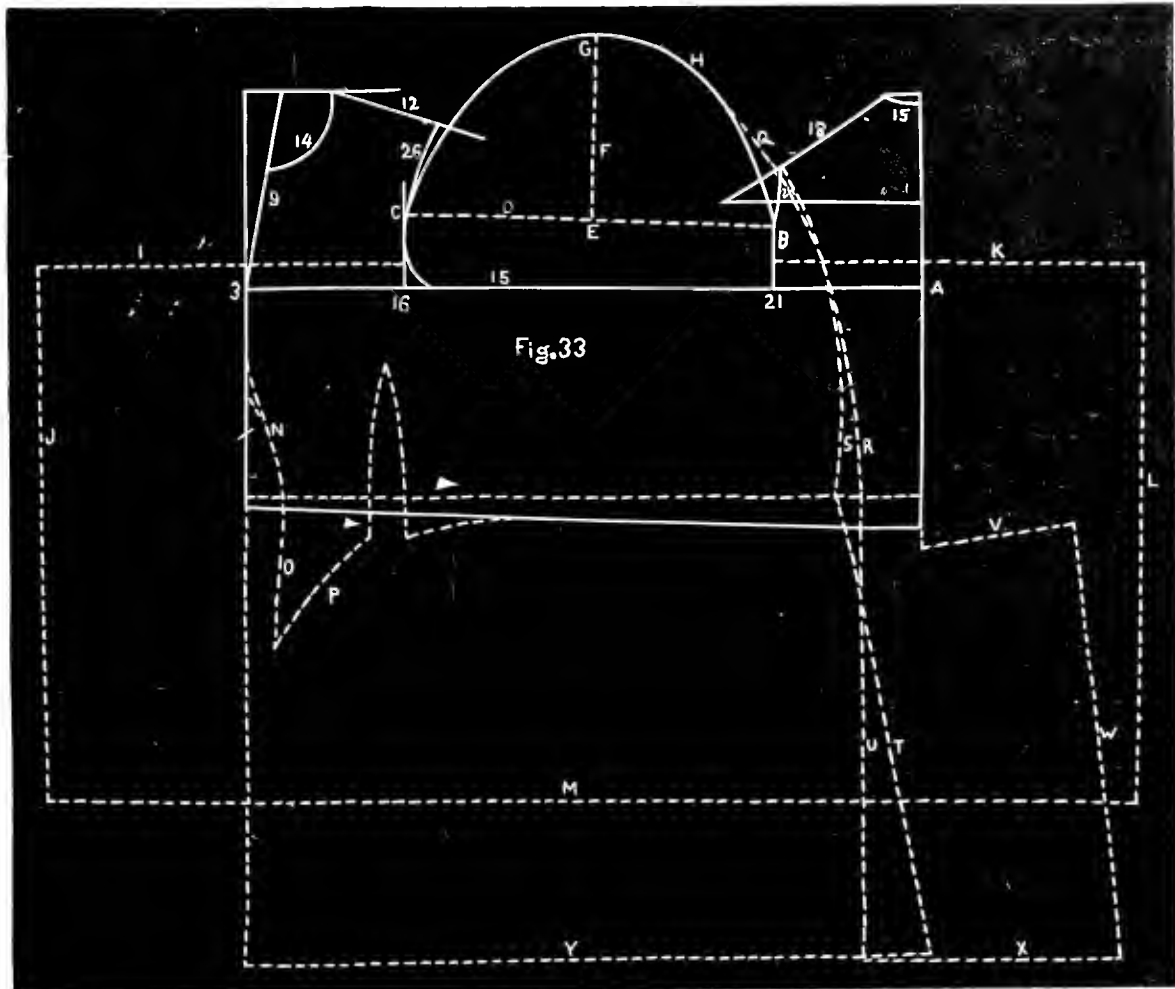

HIGH SHOULDER CAPE WITH YOKE.

Fig. 33.

Draft same as high shoulder cape in Fig. 33 except as illustrated by dotted lines I, J, K, L and M.

1. Lines I and J are drawn 1 inch above and parallel with line 15, 15 inches long or the length wanted for gathers or plaiting.

2. Lines J and L are drawn length wanted for cape or circular.

The front above line I makes the front yoke. The back above line K makes the back yoke, if wanted without seam in center of back place line 1 on fold of goods.

HIGH SHOULDER CAPE WITH TIGHT FRONT.

Fig. 33.

Draft same as high shoulder cape, except as illustrated by dotted lines N, O and P and dart in Fig. 33.

1. Lines N and O are made same as for dartless basque in Fig. 3.

2. The darts are made from 3 to 5 inches from line N and from $1\frac{1}{2}$ to $2\frac{1}{2}$ inches in size height of dart measure.

ADDRESS ALL COMMUNICATIONS TO HUGHES & STOREY, ST. LOUIS, MO.

RUSSIAN CAPE.

Fig. 33.

Draft same as high shoulder cape with the exceptions illustrated by dotted lines Q, R, S, T, U, V, W, X, Y and 1 in Fig. 33.

1. Width of back piece at waist is usually made $2\frac{1}{2}$ inches wide, but can be made any width desired.
2. Lines Q, R and S are shaped with dart curve.
3. Lines T and U are drawn same as in plain basque and any length wanted usually from 12 to 18 inches below the waist.

In cutting this garment trace lines 18, 15, 1, R, U, V, W and X for back, for front trace 1, 9, 14, 12, 26, H, Q, S, T, and Y.

RUSSIAN CIRCULAR.

Fig. 33.

Draft the same as Russian cape in Fig. 33 except that skirt lines are made $\frac{3}{4}$ or full length of skirt.

MILITARY CAPE.

Fig. 34.

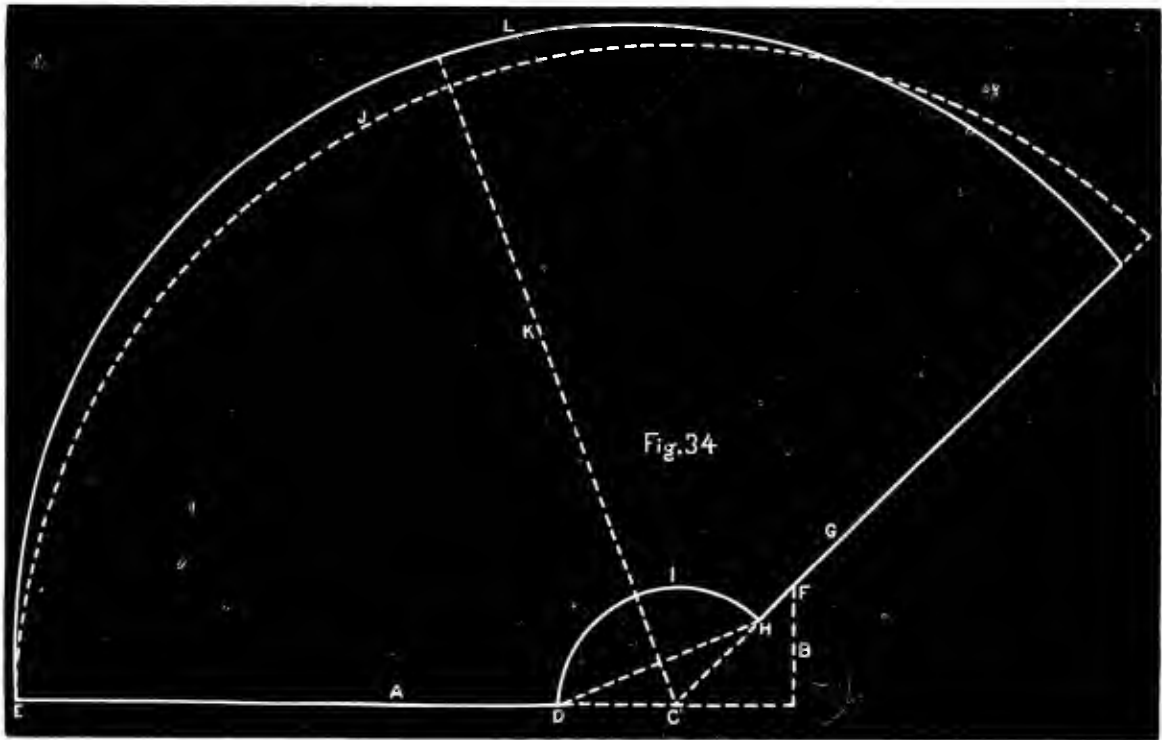

1. Draft lines A and B at right angles, and make dot C $\frac{1}{2}$ inch more than neck measure in neck figures on line A as shown in Fig. 34.

2. Make dot D $\frac{1}{2}$ inch more than neck measure in neck figures from dot C.

3. Make dot E 24 inches from dot D for length of cape in the back or length desired.

4. Make dot F $\frac{1}{2}$ inch more than neck measure in neck figures from end of line A on line B.

5. Draw line G from dot C across dot F.

6. Make dot H $\frac{1}{2}$ inch more than neck measure in neck figures from dot C on line G.

7. Sweep line I from dot D to dot H with tape line using dot C as a pivot.

8. Sweep line J from dot E to line G with tape line using dot C as a pivot.

This cape should be 1 inch longer on the side than in the back as shown by line K and front should be made 1 inch shorter than back as shown by line G then shape the bottom of this cape as illustrated by line L.

When material is wide enough place line A on fold of goods then trace lines I, L and G and you have the cape in one piece.

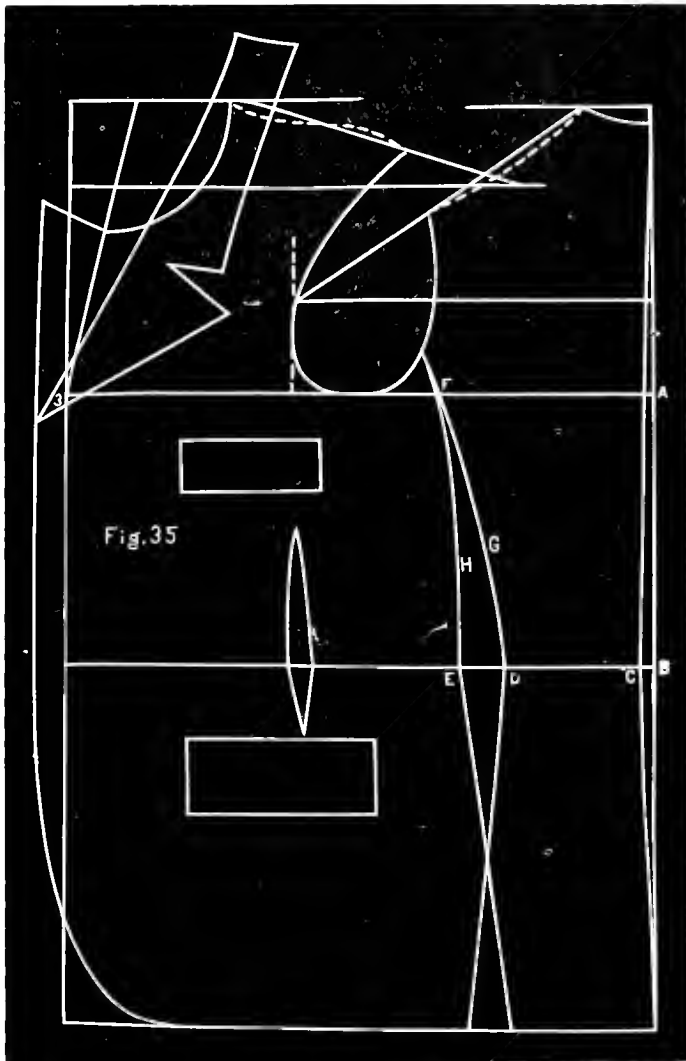

BOY'S COAT.

Fig. 35.

Measures are taken same as for ladies' basque, and is drafted the same as ladies' basque, with the following exceptions shown in Fig. 35 :

1. Make dot A the breast measure from dot 3 in half-inch figures.
2. Make dot B the under-arm measure below dot A.
3. Make dot C $\frac{1}{4}$ inch inside of dot B.
4. Make dot D 3 inches from dot C.
5. Make dot E $\frac{3}{4}$ inch from dot D.
6. Make dot F the width of back measure from dot A.
7. Draw lines G and H with dart curve.
8. Make skirt for coat as represented in Fig. 35. It is made about 8 inches long, but can be made any length desired.
9. If it is desirable to have a coat fit more closely at the waist, put a dart at waist line, placing it about 3 inches from dot E, $\frac{3}{4}$ of an inch in width, 5 inches in length, $1\frac{1}{2}$ inches long below the waist, the remainder of dart above the waist, as illustrated in Fig. 35. The remainder of the drafting, including the collar, is drafted the same as in Fig. 25.

This coat is drafted to the following measures: Neck, 11; breast, 26; waist, 24; scye, 8; front, $14\frac{1}{2}$; chest, 10; width of back, 9; length of back, 12; shoulder, 4; under-arm, 6; hip, 28; first balance, 11; second balance, $24\frac{1}{2}$.

BOYS' KNEE PANTS—FRONT.

Fig. 36.

1. Draw line A 1 inch from edge of paper.

2. Make dot B outside leg measure from top of line A.
3. Make dot C inside leg measure above dot B.
4. Draw line D square from top of line A.
5. Make dot E on line D 2 inches more than $\frac{1}{4}$ of hip measure.
6. Make dot F on line D 2 inches from dot E.
7. Make dot G on line D $\frac{1}{2}$ inch less than $\frac{1}{4}$ of waist measure from dot F.
8. Draw line H square with line D from dot E.
9. Make dot I on line H the outside leg measure from dot E.
10. Make dot J inside leg measure above dot I.
11. Draw line K from dot C to dot J.
12. Make dot L 2 inches from dot J.
13. Draw line M from dot F to dot L.
14. Make dot N on line M 2 inches above dot L.
15. Draw line O from dot J to dot N. Use arm curve.
16. Draw line P from dot B to dot I.
17. Make dot Q on line P 1 inch from dot B.
18. Make dot R on line P $\frac{1}{2}$ of knee measure from dot Q.
19. Draw line S from dot R to dot J. Use dart curve.
20. Draw line T from dot Q to dot C. Point T on system at dot Q.
21. Draw line U from dot C to dot G. Use dart curve.

BOYS' KNEE PANTS—BACK.

Fig. 37.

1. Draw line A 1 inch from edge of paper.

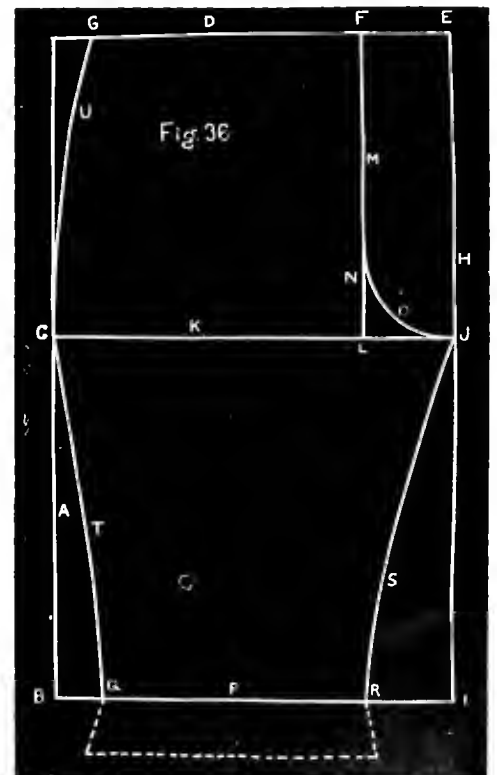

THE LADIES' TAILOR SYSTEM.

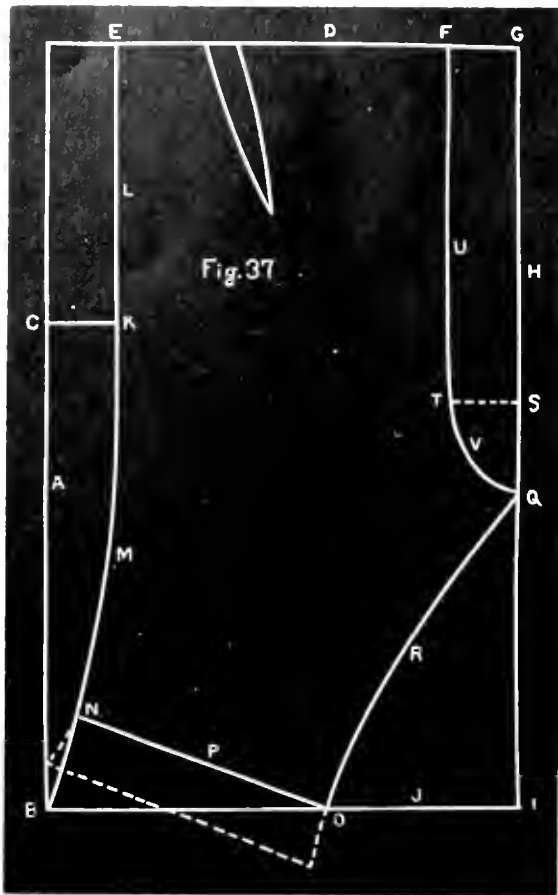

2. Make dot B 2 inches more than outside leg measure from top of line A.
3. Make dot C on line A 6 inches from top of line A.
4. Draw line D square from top of line A.
5. Make dot E $1\frac{1}{2}$ inches from top of line A.
6. Make dot F 1 inch more than $\frac{1}{4}$ of waist measure from dot E.
7. Make dot G $1\frac{1}{2}$ inches from dot F.
8. Draw line H square with line D from dot G.
9. Make dot I 2 inches more than outside leg measure from dot G.
10. Draw line J from dot B to dot I.
11. Make dot K $1\frac{1}{2}$ inches inside of dot R.
12. Draw line L from dot E to dot K.
13. Draw line M from dot B to dot K, use dart curve.
14. Make dot N 2 inches from dot B on line M.
15. Make dot O on line J $\frac{1}{2}$ of knee measure from dot N.
16. Draw line P from dot N to dot O.
17. Make dot Q on line H the same distance from dot O that dot J is from dot R in front drafting.
18. Draw line R from dot O to dot Q, use dart curve.
19. Make dot S 2 inches above dot Q on line H.
20. Make dot T $1\frac{1}{2}$ inches inside of dot S.
21. Draw line U from dot F to dot T.

22. Draw line V from dot Q to dot T, use arm curve.
23. Make a sloping dart $\frac{1}{2}$ inch in width and 4 inches long from waist line. The dart should be placed about 2 inches from dot E.

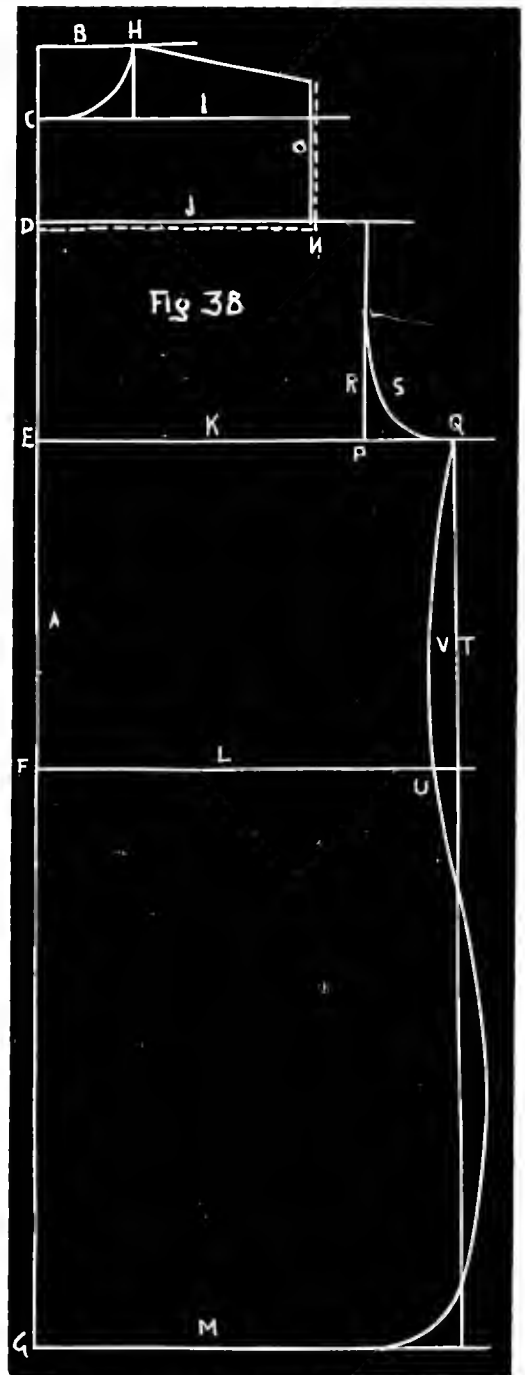

BACK OF SHIRT.

Fig. 38.

1. Draw lines A and B at right angles.
2. Make dot C $\frac{1}{8}$ of neck measure from top of line A.
3. Make dot D 3 inches from dot C or width desired for yoke.
4. Make dot E $\frac{1}{4}$ of breast measure from dot C.
5. Make dot F $\frac{1}{4}$ of breast measure from dot E.
6. Make dot G length of shirt from dot C.
7. Make dot H $\frac{1}{2}$ inch more than $\frac{1}{8}$ of neck measure from top of line A.
8. Draw lines I, J, K, L and M square from line A.
9. Make dot N the length of yoke from dot D.
10. Draw line O square from dot N to a point 1 inch above line I and draw shoulder line to it.
11. Make dot P $\frac{1}{4}$ of breast measure from dot E.
12. Make dot Q $2\frac{1}{2}$ inches from dot P.
13. Draw line R square from line K to line J then draw line S with arm curve.
14. Draw line T square from line K.
15. Make dot U $\frac{1}{4}$ inch inside of line T and shape line V with dart curve, as illustrated in Fig. 38 dotted lines represent yoke. Line J is gathered into the yoke.

ADDRESS ALL COMMUNICATIONS TO HUGHES & STOREY, ST. LOUIS, MO.

THE LADIES' TAILOR SYSTEM.

FRONT OF SHIRT.

Fig. 39.

1. Draw lines A and B at right angles.
2. Make dot C the neck measure in neck figures from top of line A.
3. Make dot D $\frac{1}{6}$ of breast measure from top of line A.
4. Make dot E $\frac{1}{4}$ of breast measure from dot D.
5. Make dot F the same distance from dot E that dot G is from dot F in back draft.
6. Make dot G $\frac{1}{8}$ of neck measure from top of line A.

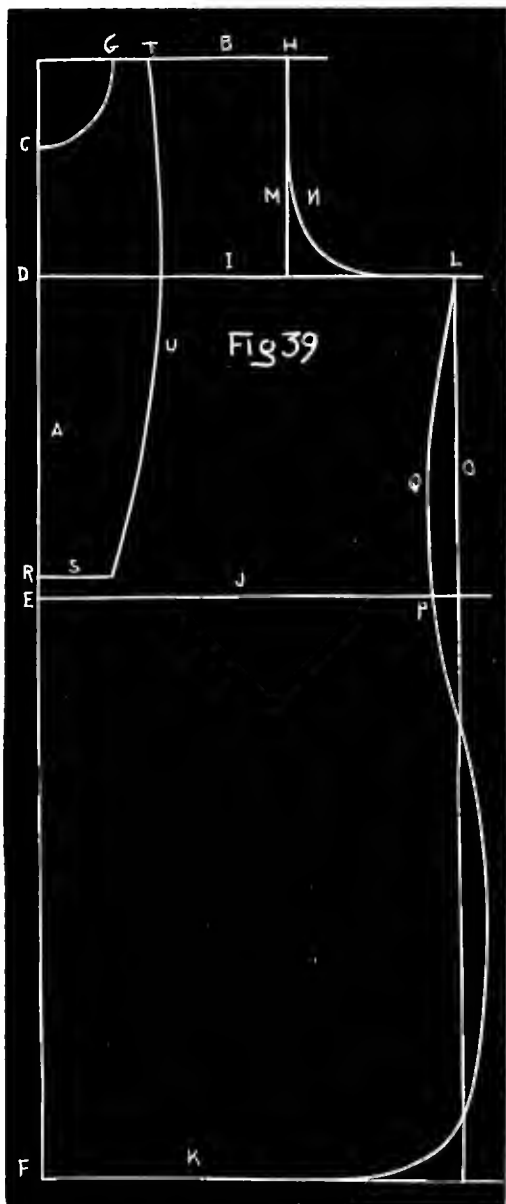

7. Make dot H the same distance from dot G that end of line O is from dot H in back draft.
8. Draw lines I, J and K square from line A.
9. Make dot L $2\frac{1}{2}$ inches more than $\frac{1}{4}$ of breast measure from dot D.
10. Draw line M square from dot H to line I then draw line N with arm curve.
11. Draw line O square from dot L.
12. Make dot P $\frac{3}{4}$ inch inside of line O then shape line Q with dart curve as illustrated in Fig 39.

SHIRT BOSOM.

Fig. 39.

1. Make dot R 1 inch above dot E.
2. Draw line S 2 inches long from dot R.
3. Make dot T 1 inch from dot G.
4. Draw line U with dart curve from dot T to end of line S.

SHIRT SLEEVE.

Fig. 40.

1. Draw line A length of sleeve less the width of cuff.
2. Draw lines C and B at right angles with line A.
3. Make dot D $\frac{1}{2}$ arms eye measure from end of line A.
4. Draw line E square from dot D and make dot F $\frac{1}{4}$ of arms-eye measure from dot D.
5. Draw line G straight from dot F to end of line A.

6. Draw line H with arm curve from dot F to end of line A.
7. Make dot I 6 inches from end of line A.
8. Draw line J straight from dot I to dot F. Cuff is made 2 inches wide and any length wanted.

SHIRT NECK BAND.

Fig. 40.

1. Draw line A and B at right angles.
2. Make dot C $\frac{1}{2}$ of neck measure from line B.

ADDRESS ALL COMMUNICATIONS TO HUGHES & STOREY, ST. LOUIS, MO.

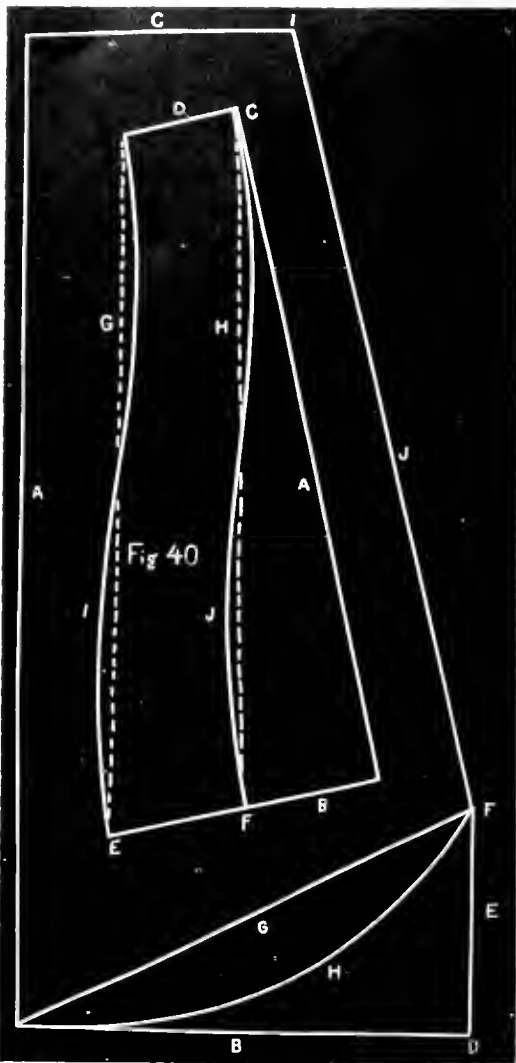

3. Draw line D square from dot C $1\frac{1}{4}$ inch long.
4. Make dot E 3 inches from end of line A.
5. Make dot F $1\frac{1}{2}$ inches from dot E.
6. Draw dotted line G from dot E to end of line D.
7. Draw dotted line H from dot F to dot C.
8. Shape lines I and J with dart curve.

This gives one half of neck band, no seams allowed in making up.

Measures for shirt, neck 15, breast 36, length 34, arms-eye 20, length of sleeve 24. Arms-eye is taken very loosely.

DRAFTING ON THE LINING.

Inquiry is sometimes made for instructions for drafting on the lining instead of on drafting paper. To meet the wishes of this class of customers we give the following instructions for doing so. We advise all who use The Ladies' Tailor to follow the example of the best tailors and make their drafts on paper for the following reasons:

1. It is always more accurate. In drawing on the lining the material will always stretch or give a little in drafting, while paper cannot.
2. By tracing from paper drafting, you always have the stitching line clearly marked.
3. If paper is used you can always test your drafting with tape line and if there is an error made in making up it can be readily proven, and the mistake of the one who makes the garment corrected, otherwise the fault would often be charged to the cutter when she was not to be blamed.

4. It saves time, when all the preliminary part of dressmaking is done accurately, all the time is saved that is lost in refitting and changing, besides the drafting can often be used to cut out several dresses for a customer, while if drafting is made on the lining a draft must of course be made for each garment cut.

FRONT DRAFT.

Fig. 41.

1. Make front same as instruction draft omitting the lines for the under-arm piece.
2. Make a new dot 4 inches outside of dot 20, and draw new lines 21 and 30 from it.
3. Make a new dot 4 inches from dot 17 and draw line 18 from it.
4. Draw skirt lines as shown in Fig. 41

BACK DRAFT.

Fig. 42.

The easiest way to learn to draft on lining is as follows.

1. Draw the back draft same as instruc-

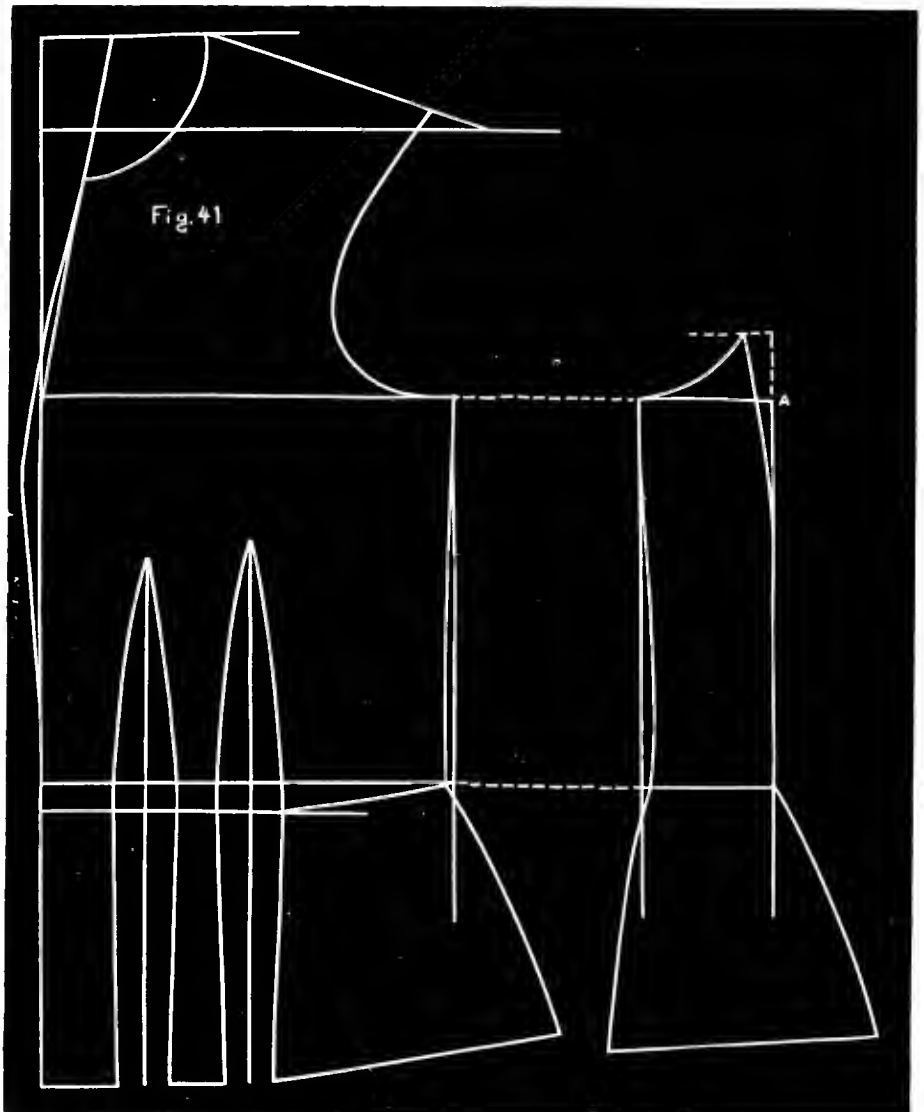

THE LADIES' TAILOR SYSTEM.

tion draft making all the dots, but omitting the lines for side body.

2. Draw the back piece same as instruction draft.
3. Draw lines across dot 25 and 23 square from line 1 as shown in Fig. 42.
4. Move side body over $1\frac{1}{2}$ inches by making new dots $1\frac{1}{2}$ inches outside of each of the dots marked 25, 23, 21, 10, 11, 33 and 29 in instruction draft and drawing side body to these new dots in the same manner as illustrated in Fig. 42.

CUTTING THE LINING.

Fig. 43.

After tracing the lining as per instructions in instruction book, remove the drafting and cut the lining allowing a full half inch for seams, except at neck and arm-hole and one and a half inches in front for laps. Do not cut out the darts until after they are basted. The seams allowed should be cut evenly. A lining with its edges uneven and ziz zag having a slovenly appearance is usually followed by a poorly made and ill-fitting garment.

CUTTING THE MATERIAL.

Fig. 43.

Place each piece of the lining separately on the material and cut out the goods, allowing about a fourth inch wider seams than for the lining. When cut pin the lining and material of each separate piece together, roll each piece up separately ready for basting and thus avoid the danger of cutting two pieces for one side or having the pieces separated or changed. Be very careful to cut goods so that the grain or thread of the material will be precisely the same as the grain or thread of the lining and both should be cut so as to run even with the waist line. The only exception to this rule is when figured, plaid or striped goods are used, and a part of the dress is cut on the bias of the goods.

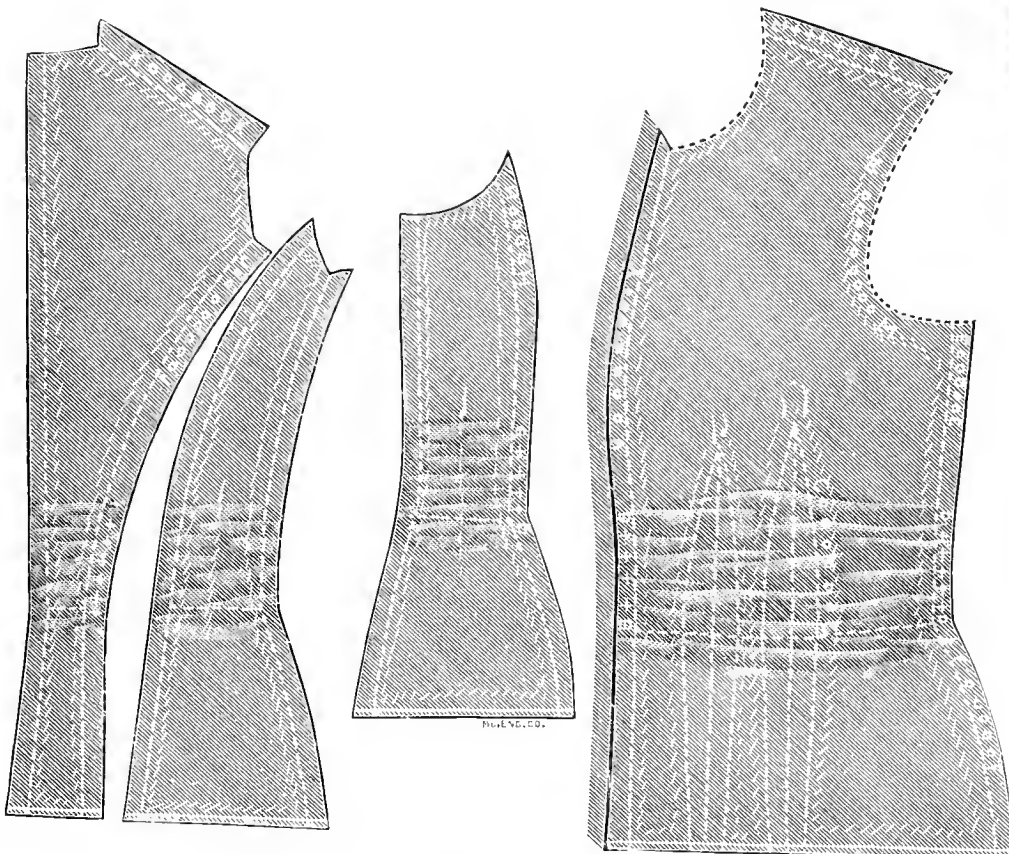
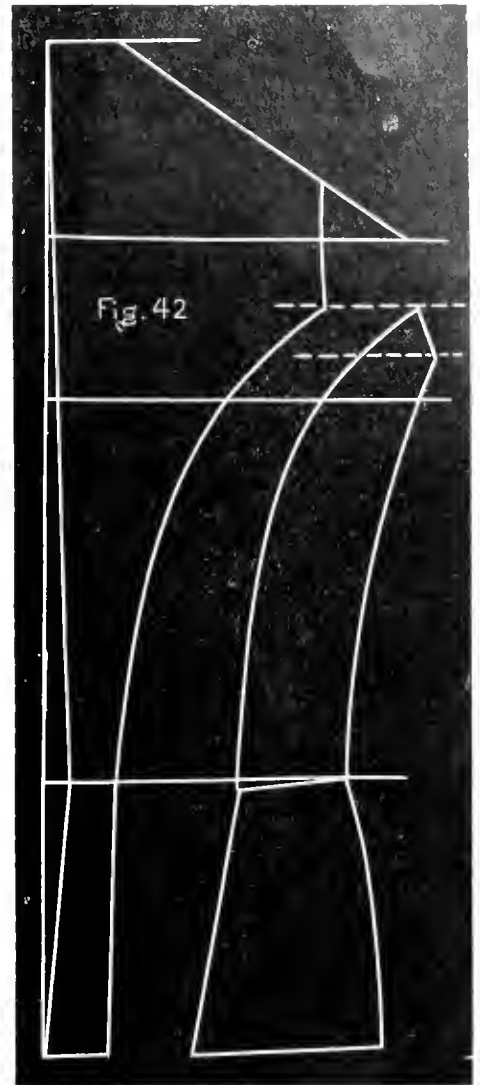

HOW TO BASTE THE SEAMS TO AVOID WRINKLES.

Fig. 43.

In lesson on basting given in our first instruction book full directions are given about fulling the lining on goods. How to do this properly is well illustrated in Fig. 43.

First baste the darts beginning about one-fourth inch above the first dart and baste evenly to the bottom of the dart. When the second dart is straight baste in the same manner. The goods between the darts from a point two inches below the waist should be stretched a very little to keep it from wrinkling. When the French Bias Dart is used it should be held a little full from CC as illustrated in Fig. 43, and the remainder of the dart

ADDRESS ALL COMMUNICATIONS TO HUGHES & STOREY, ST. LOUIS, MO.

THE LADIES' TAILOR SYSTEM.

should be basted evenly. In basting the under-arm piece on to the front begin at the waist line and baste up to the arm-hole, stretch the front a little at the point marked D D and full it a little at the point marked E E. Then baste from the waist line down and full the front about one-fourth inch at the point marked F F. In basting the side-body on to the back the back should be stretched a little at the point marked I I, and full about one-fourth inch on to the side-body at the point marked J J. These two pieces should be pinned together carefully before basting so as to keep the fullness at the proper place and to keep the waist line from twisting. Always hold the back piece next to you in basting on the side-body, then baste evenly below the waist line. Baste the two back pieces together evenly. In basting the under-arm piece on the side-body it should be held a little full at the point marked H H and stretched a very little at the point G G. In basting the shoulder seams together full the back to the front one-fourth inch at K K and stretch the front one-fourth inch at L L. To keep the arm-hole from stretching run a strong thread around the arm-hole in the seam, fulling it slightly at the point marked M M. Another plan is baste a narrow tape around the arm-hole and stitch it fast in the seam. All curved or French fronts should be stretched about one-fourth inch at the point marked B B, and full from one-fourth to one-half inch at the point marked A A. After basting trim the edges even with the lining.

BASTING THE SLEEVE.

Commence at the top of inside seam and baste to the bottom perfectly smooth. When basted lay the sleeve on a table flat and smooth, under part on the top. Pin outside seam smoothly beginning at the top of sleeve in tracing marks to elbow. Then pin from wrist to within $1\frac{1}{2}$ inches of elbow smoothly and gather the fullness evenly in the space of $1\frac{1}{2}$ inches at elbow. Baste smoothly in tracing marks. When the sleeve is properly basted it will lay flat and smooth on the table.

In drafting sleeves, the top of the sleeve for all tight fitting garments should be from two to three inches larger than the arm-hole of the waist and the fullness sewed in over the most rounding part. In outside garments it should be about one and a half inches larger than the arm-hole and most of the fullness put around the top of the arm.

SUGGESTIONS ON FITTING.

It sometimes happens especially with beginners in dresscutting that after taking a measure basting and trying on a garment that it does not fit, and the seamstress often feeling positive that she could not have made a mistake falls into the error of thinking that the old reliable square of inches might possibly be wrong and condemns her System. The truth is that those who use The Ladies' Tailor System would never have any refitting to do if it were not "human to err," but the cutter or dressmaker does not live who is not liable to make a mistake either in taking the measure, making a drafting, tracing the material, or in making up the goods; and an error in any of these things will make some change necessary. It is therefore well that all should know what the results of bad measures are and how to fit a garment when errors are made.

1. When the neck measure is too large there will be looseness around the neck near the shoulder. Take up the shoulder seam.
2. When the arms-eye measure is too large the sleeve will be too large at arm-hole. Fit on the outside seam.
3. When the bust measure is too large there will be fullness under the arms or in front. Take up on the under-arm seam.
4. When the bust measure is too tight the dress will bind across the front causing an indenture near the arms. Let out the under-arm seam: Add some goods down the front line.
5. When the waist measure is too large the dress will be too loose. Take up the under-arm seam.
6. When the waist measure is too tight add goods on the under-arm seam.
7. When the hip measure is too tight wrinkles will be caused about the waist and over the hips. Loosen skirt lines and fit them smoothly.
8. When the width of the back is too wide it will give a broad appearance across the back and make the arm-hole too small. Trim out the arm-hole in back.
9. When the width of back is too narrow let out in centre of back and take up on the under-arm seam.
10. When the length of the back measure is too long the dress will wrinkle across the back and will be too high near the neck. Trim out the neck and take up on the shoulder seams. To avoid this trouble never take the length of back measure below the level line as shown in diagram B of instruction book. If extra length in back is necessary add below natural waist line as shown by lines B and D in Fig. 5 in instruction book.
11. When the under-arm measure is too long the dress will wrinkle under the arms. Trim out arm-hole under the arm. When this measure is too short the garment will be too high at the neck and short waisted. Trim out back of neck and take up the back shoulder seam and fit it down to the waist.

ADDRESS ALL COMMUNICATIONS TO HUGHES & STOREY, ST. LOUIS, MO.

THE LADIES' TAILOR SYSTEM.

12. When the balance measures are too long it will be loose on the shoulders. Take up on shoulder seam. When balance measures are too tight the garment will be too tight on shoulders. Let out shoulder seams.

13. When the front measure is too long the dress will wrinkle in front near the waist. Fit on the shoulder seam. When too short the garment will be too short in front. Fit at waist line.

14. When the scye measure is too long the arm-hole will be too deep and it will be necessary to fit on shoulder seam and skirt lines. When the scye measure is too short the arm-hole will not be sufficiently deep and will cause wrinkles in front near the arm. Trim out at arm-hole.

15. If the height of dart measures are either too long or short they will be either too high or low in the garment. If too high they should be lowered and if too short they should be raised, being careful not to increase or decrease the width of the darts at waist line.

Remember that many a garment has been cut out well and when made up is distorted and full of wrinkles not fitting smoothly caused by poor basting. Study instructions on basting.

TABLE SHOWING THE AMOUNT OF GOODS REQUIRED.

This table is based on medium sized figures and will answer for 34, 36 or 38 bust measure. When there is much variations in size or in length of skirt a little must be deducted or added as good judgment suggests.

In using this table find the style of garment and follow the line until the column is reached which gives the width of your material. At this point you will find the amount of goods needed.

STYLE OF GARMENT.	DIFFERENT WIDTH OF GOODS IN INCHES.						
	18	20	22	24	27	36	48
Plain dress.....	15	13 $\frac{1}{2}$	12	11	10	7 $\frac{1}{2}$	5 $\frac{1}{2}$
Fancy dress.....	19 $\frac{1}{2}$	17 $\frac{1}{2}$	16	14 $\frac{3}{4}$	13	10	7 $\frac{1}{2}$
Round waist.....	2 $\frac{1}{2}$	2 $\frac{1}{4}$	2	1 $\frac{3}{4}$	1 $\frac{3}{8}$	1 $\frac{1}{2}$	1
Basque.....	6 $\frac{1}{2}$	5 $\frac{1}{2}$	5	4 $\frac{1}{4}$	4	3	2 $\frac{1}{4}$
Polonaise.....	9 $\frac{3}{4}$	8 $\frac{3}{4}$	8	8 $\frac{1}{3}$	6 $\frac{1}{2}$	5	3 $\frac{3}{4}$
Princess.....	12 $\frac{1}{4}$	11	10	9	8	6	4 $\frac{1}{2}$
Princess with full train.....	19 $\frac{1}{2}$	17 $\frac{1}{2}$	16	14 $\frac{1}{2}$	13	10	8
Ladies' coat.....	5 $\frac{1}{2}$	5	4 $\frac{1}{2}$	4	3 $\frac{3}{4}$	2 $\frac{3}{4}$	2
Long double breasted coat.....	7	6	5 $\frac{1}{2}$	5	4 $\frac{1}{2}$	3 $\frac{1}{2}$	2 $\frac{3}{4}$
Short cape or wrap.....	3	2 $\frac{3}{4}$	2 $\frac{1}{2}$	2 $\frac{1}{4}$	2	1 $\frac{3}{4}$	1 $\frac{1}{2}$
Cloak or long wrap.....	8 $\frac{1}{2}$	7 $\frac{3}{4}$	7	6 $\frac{1}{2}$	5 $\frac{3}{4}$	4 $\frac{1}{2}$	3 $\frac{1}{4}$
Dolman.....	5 $\frac{1}{2}$	5	4 $\frac{1}{2}$	4	3 $\frac{3}{4}$	3	2 $\frac{1}{2}$
Long dolman.....	6 $\frac{1}{4}$	5 $\frac{1}{2}$	5	4 $\frac{1}{3}$	4	3 $\frac{1}{2}$	2 $\frac{1}{4}$
Plain skirt.....	9 $\frac{1}{4}$	9	8	7 $\frac{1}{4}$	6 $\frac{1}{2}$	5	3 $\frac{3}{4}$
Fancy skirt.....	12 $\frac{1}{4}$	11	10	8 $\frac{1}{4}$	8	6	4 $\frac{1}{2}$
Plain sleeve.....	1 $\frac{1}{2}$	1 $\frac{1}{4}$	1	1	$\frac{3}{4}$	$\frac{2}{3}$	$\frac{1}{2}$
Fancy sleeve.....	2 $\frac{1}{2}$	2 $\frac{1}{4}$	2	1 $\frac{3}{4}$	1 $\frac{1}{2}$	1 $\frac{1}{4}$	1

ADDRESS ALL COMMUNICATIONS TO HUGHES & STOREY, ST. LOUIS, MO.

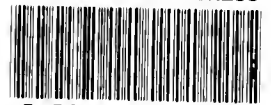

* * * INDEX * * *



PAGE	PAGE		
Blazer.	8	Index	40
Boys' Coat.	33	Ladies' Walking Jacket	28
Boys' Knee Pants.	33	Ladies' Box Coat.	29
Back for Coat or Jacket.	8	Ladies' Dolman	29
Back of Gent's Shirt.	31	Military Cape	32
Bishop Sleeve.	10	Newmarket.	28
Bell Sleeve.	11	One-seam Sleeve.	9
Bell Skirt.	14	Parisian Dartless Basque.	7
Back of Princess.	18	Plain Round Skirt.	15
Back of Riding Habit Skirt.	25	Pointed Collar	16
Back of Riding Habit Trousers.	27	Princess Corsage, with Bell back.	18
Basting the Sleeve.	38	Princess, with Bell back.	19
Collar and Lapel together.	17	Roll Collar	16
Cutting the Lining.	37	Russian Cape	32
Cutting the Material.	37	Russian Circular	32
Double-Breasted Coat	7	Seven-gored Skirt.	15
Dartless Coat, Tight-fitting.	8	Shirt Bosom	35
Dartless Half-fitting Coat	8	Shirt Neck Band	35
Dartless Three-quarter Coat.	8	Shirt Sleeve for Ladies' Dress.	10
Dartless Princess.	21	Shirt Sleeve	35
Dartless Draped Princess	21	Shawl Collar.	17
Drafting on the Lining.	36	Seamless Dress.	21
French Bias Basque, with straight front	5	Seamless Princess	22
French Bias Basque, with French front.	5	Suggestions on Fitting	38
French Bias Basque, with two under-arm pieces.	6	The French back.	8
Full dress Sleeve.	9	The Ladies' Tailor Favorite Sleeve	11
Full dress Bell Sleeve	11	Tight-fitting Sleeve.	11
French Tight-fitting Sleeve.	12	The Coat Sleeve.	12
Fan-back Skirt	14	The Worth Skirt.	13
Front of Riding Habit Skirt	26	The Standing Collar.	16
Front of Riding Habit Trousers.	27	Turn-down Collar	17
Front of Gent's Shirt	35	The Princess.	18
Girdles.	17	The Ladies' Tailor Seamless Waist.	22
How to Draft the Back in six pieces.	9	The Riding Habit.	24
How to Trace out the Princess	20	The Lapel and Collar.	24
How to Baste the Seams to avoid wrinkles.	37	The Ladies' Double-Breasted Prince Albert Coat	28
High Shoulder Cape.	30	Table showing the amount of goods required.	39
High Shoulder Cape, with Yoke	31	Umbrella Skirt	15
High Shoulder Cape, with tight front.	31	Ulster.	28



LIBRARY OF CONGRESS



0 013 964 967 9